



Maschinen von Witzig & Frank fertigen auch Ihr Werkstück

Your workpiece – produced by machines of Witzig & Frank

你的工件 – 在Witzig & Frank机床上加工

Witzig & Frank entwickelt und baut hochproduktive Anlagen für die Produktion kleiner bis mittelgroßer Bauteile in der Sanitär- und Armaturenindustrie, dem Automobil- und Maschinenbau. Unsere Leistungen umfassen die Prozessentwicklung anhand des Kundenwerkstücks, die Integration von Zusatztechnologien sowie die Auslegung und Umsetzung von Turnkey-Anlagen durch erfahrene Ingenieure. Unsere in Deutschland gefertigten Anlagen exportieren wir in alle Industrienationen und unterstützen unsere Kunden durch zuverlässigen Service über den kompletten Produktionszyklus sowie Ingenieursdienstleistungen wie Umbauten und Retrofits.

Witzig & Frank is the leading brand for highly productive manufacturing systems in the Faucet and Fittings, Automotive, and Industrial Equipment industries for small to medium sized parts. Our approach includes work piece dedicated application, the integration of multiple technologies and turnkey system development and design, handled by experienced engineers. We manufacture in Germany and deliver our solutions to all industrialized nations, providing maintenance, service and support during the entire machine life cycle, including retooling, retrofit and service contracts

Witzig & Frank是为汽车行业，水暖行业，以及其它工业领域提供中小工件高效制造系统的领先品牌。我们的方法包括工件的专用的应用程序，多种工艺技术综合和交钥匙工程的开发与设计，这些都由经验丰富的工程师处理。我们制造在德国，为所有的工业化国家提供我们的解决方案，并且在整个设备生命周期内提供维修服务和技术支持，包括重组工装，翻新改造和服务合同。

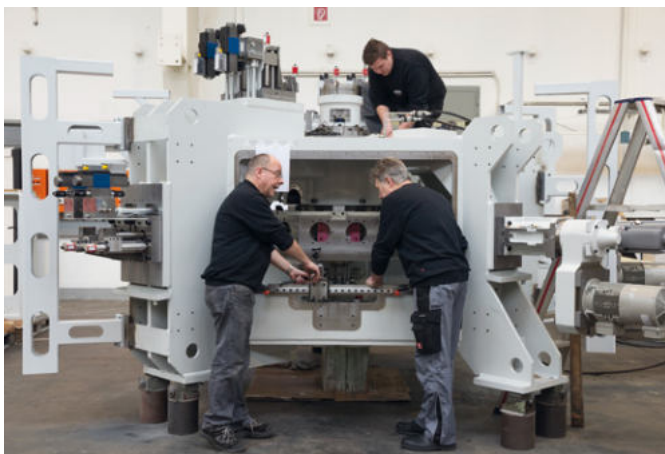
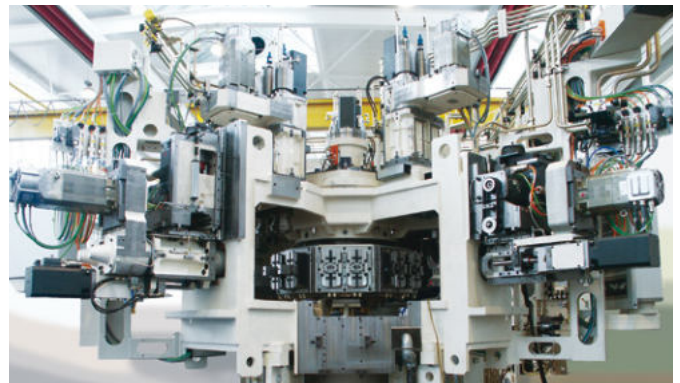

Eine Auswahl an Werkstücken, die bisher auf Witzig & Frank-Maschinen bearbeitet wurden

A collection of workpieces produced on Witzig & Frank machines

Witzig & Frank 机床加工的典型工件

Automotive

Automotive

汽车行业

- ▶ Achse – Axle – 车桥 4
- ▶ Bremse – Brake – 制动 6
- ▶ Getriebe – Transmission – 变速箱 7
- ▶ Differential – Differential – 差速器 9
- ▶ Lenkung – Steering – 转向器 10
- ▶ Innenraum – Interior – 内饰件 12
- ▶ Motor – Engine – 发动机 13
- ▶ Motorrad – Motorcycle – 摩托车 17
- ▶ E-Antrieb – E-drives – 电动汽车 18



Automotive – Automotive – 汽车行业

Armaturen/Sanitär

Faucet/Fittings

水暖行业

- ▶ Gebäudeinstallation – Plumbing – 管道设备 19
- ▶ Fittings – Fittings – 管件 20
- ▶ Mischarmaturen – Faucets – 水龙头 22
- ▶ Verschraubungen – Screw fittings – 螺纹连接件 23
- ▶ Verteilergehäuse – Manifold housings – 歧管 24

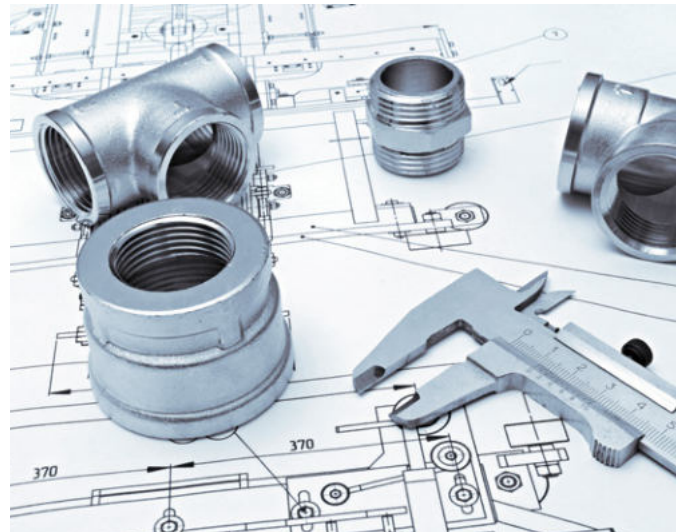

Armaturen/Sanitär – Faucet/Fittings – 水暖行业

Industrial Equipment

Other industry branches

工业设备

- ▶ Baumaschinen – Construction equipment – 建筑设备 25
- ▶ Waschmaschine – Washing machines – 洗衣机 26
- ▶ Kompressoren – Compressors – 压缩机 26
- ▶ Türschließgehäuse – Door lock housings – 闭门器 26
- ▶ Zapfhahngehäuse – Fuel filler nozzle housing – 加油器喷嘴壳体 27
- ▶ Werkzeug – Tools – 工具 27



Industrial Equipment – Other industry branches – 工业设备

Automotive – Automotive – 汽车行业

Achse – Axle – 车桥

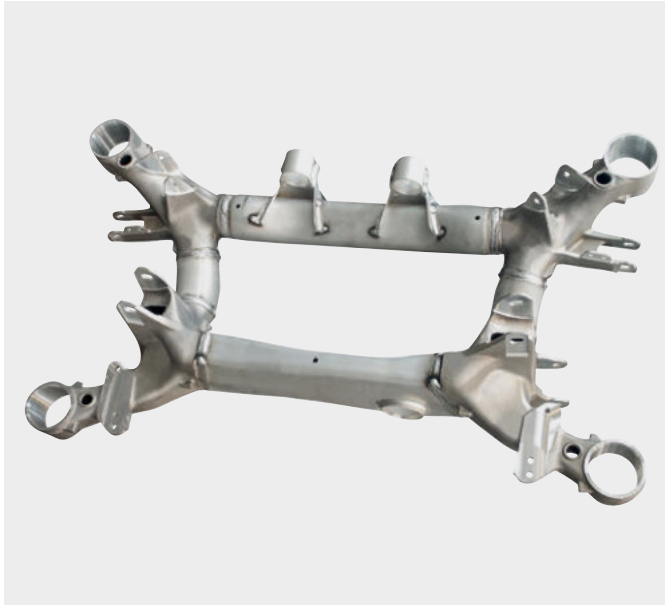

Hinterachsträger

Werkstoff: Al

Cast joint

Material: aluminum

铸造链接件

材料: 铝合金



Gussknoten

Werkstoff: Al

Cast joint

Material: aluminum

铸造链接件

材料: 铝合金



Achsträger vorn

Werkstoff: Al

Leading cross member

Material: aluminum

引导横梁

材料: 铝合金



Armgehäuse

Werkstoff: Al

Arm case

Material: aluminum

摇臂

材料: 铝合金

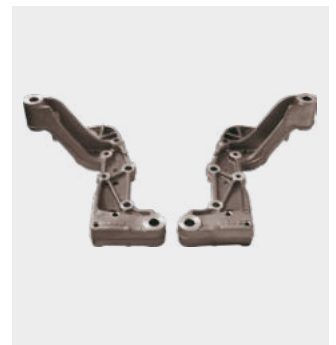

Konsole (paarweise gespannt)

Werkstoff: Al

Bracket (clamped set)

Material: aluminum

支架(卡紧组件)

材料: 铝合金



Schwenklager

Werkstoff: GG

Knuckle

Material: gray cast iron

转向节

材料:灰铸铁



Achsträger

Werkstoff: GG

cross member

Material: gray cast iron

转向节

材料:灰铸铁

Automotive – Automotive – 汽车行业

Bremse – Brake – 制动



Traverse

Werkstoff: St

Traverse

Material: steel

横盖

材料: 钢



Bremssattel

Werkstoff: GG

Calliper

Material: gray cast iron

卡尺

材料: 灰铸铁



Radbremsszylinder

Werkstoff: GG

Wheel brake cylinder

Material: gray cast iron

车轮油缸

材料: 灰铸铁



Gehäuse für Bremshydraulik

Werkstoff: GG

Hydraulic brake housing

Material: gray cast iron

车轮油缸

材料: 灰铸铁

Automotive – Automotive – 汽车行业

Getriebe – Transmission – 变速箱

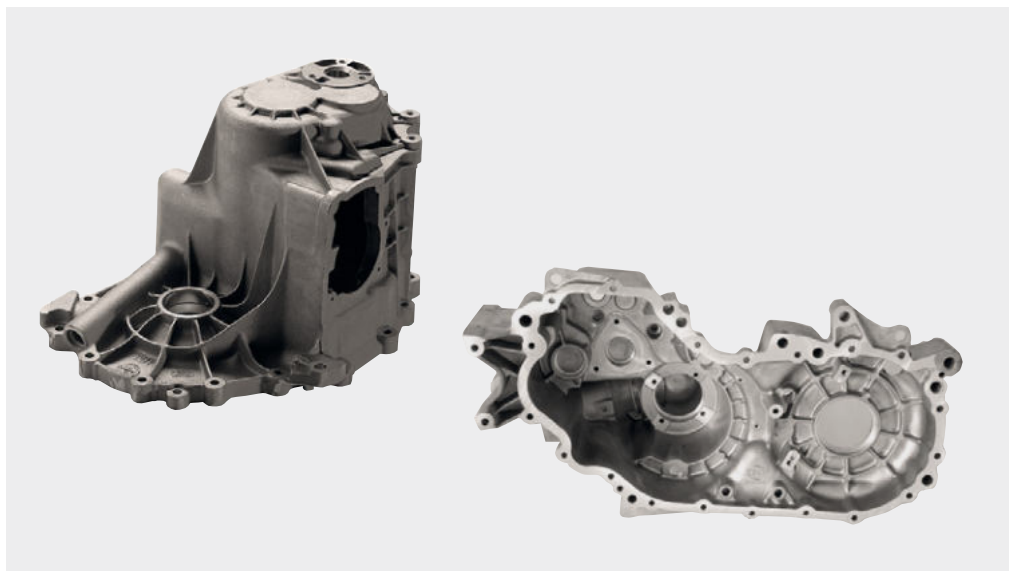

Getriebegehäuse

Werkstoff: Al

Gear box

Material: aluminum

齿轮箱

材料: 铝合金

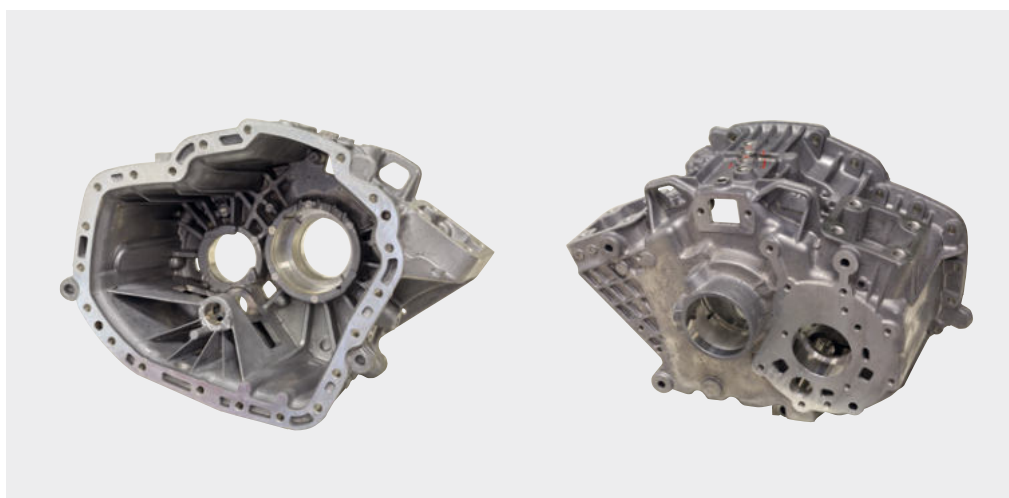

Kupplungsgehäuse

Werkstoff: Mg

Clutch housing

Material: magnesium

离合器壳体

材料: 镁合金



Hinterachsgetriebegehäuse

Werkstoff: Al

Rear axle transmission housing

Material: aluminum

差速器壳支撑

材料: 铝合金

Automotive – Automotive – 汽车行业

Getriebe – Transmission – 变速箱



Primärpumpe

Werkstoff: GG

Primary pump

Material: gray cast iron

初级泵

材料: 灰铸铁



Ölpumpengehäuse

Werkstoff: Al

Oil pump housing

Material: aluminum

油泵壳体

材料: 铝合金



Antriebswelle

Werkstoff: GG

Reactor shaft

Material: gray cast iron

响应轴

材料: 灰铸铁



Planetenträger vorn

Werkstoff: Al

Pinion gear cage

Material: Al

主动齿轮笼

材料: 铝合金



Planetenträger hinten

Werkstoff: Al

Pinion gear cage, rear set

Material: aluminum

主动齿轮笼, 后组

材料: 铝合金



Gelenkgabel

Werkstoff: GJMB

Yoke

Material: malleable Iron

支座

材料: 可锻铸铁

Automotive – Automotive – 汽车行业

Differential – Differential – 差速器



Differentialgehäuse

Werkstoff: GGG

Differential housing

Material: gray cast iron

差速器壳体

材料: 灰铸铁



Differentialgehäuse

Werkstoff: GJMB

Differential housing

Material: malleable iron

差速器壳体

材料: 可锻铸铁

Automotive – Automotive – 汽车行业

Lenkung – Steering – 转向器

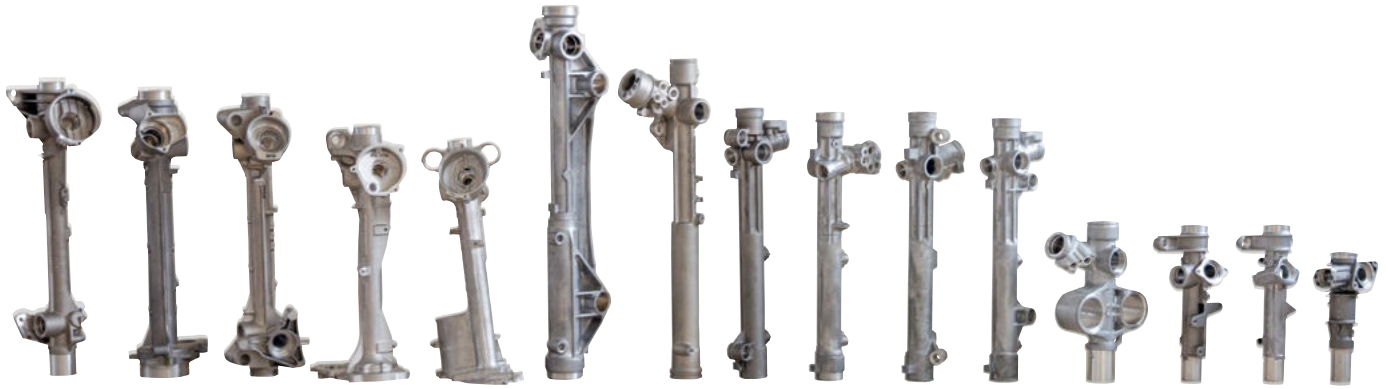

Lenkgehäuse - H

Werkstoff: Al

Steering housing - H

Material: aluminum

转向器壳体 - H

材料: 铝合金



Lenkgehäuse - E

Werkstoff: Al

Steering housing - E

Material: aluminum

转向器壳体 - E

材料: 铝合金

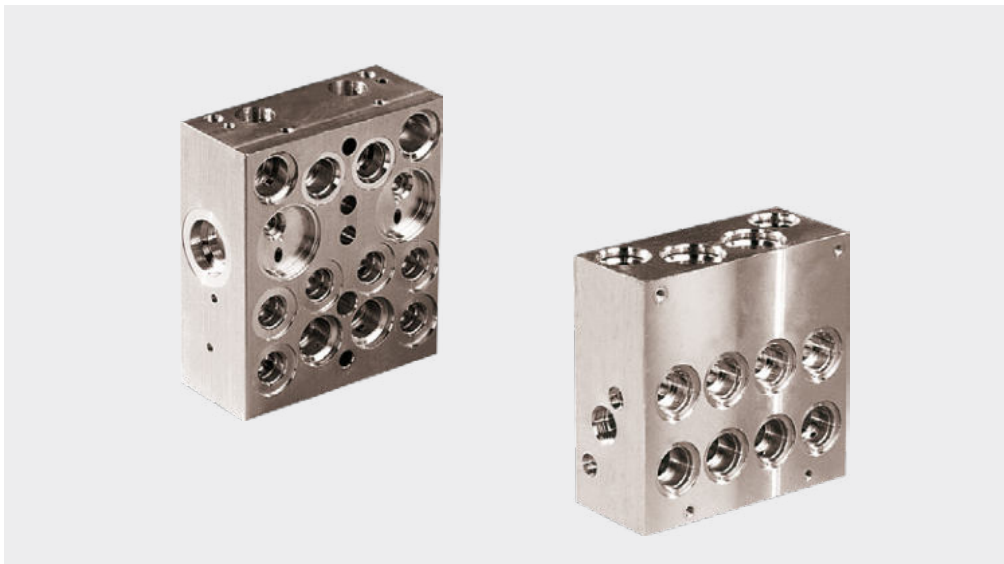

ABS-Ventilgehäuse

Werkstoff: Al

ABS valve body

Material: aluminum

ABS 阀体

材料: 铝合金

**Pumpengehäuse**

Werkstoff: Al

Pump housing

Material: aluminum

动力转向泵壳

材料: 铝合金

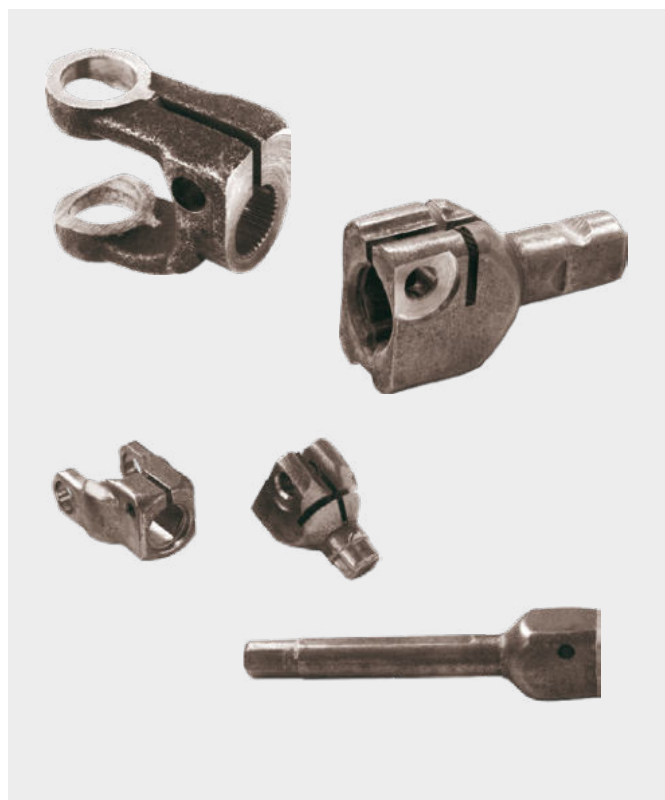
**Lenkgabel / Lenzapfen**

Werkstoff: St

Universal joint

Material: steel

万向节

材料: 钢

**Ventilgehäuse**

Werkstoff: GG

Valve body

Material: gray cast iron

伺服转向阀体

材料: 灰铸铁

**Deckel**

Werkstoff: Al

Cover

Material: aluminum

盖

材料: 铝合金

Automotive – Automotive – 汽车行业

Innenraum – Interior – 内饰件

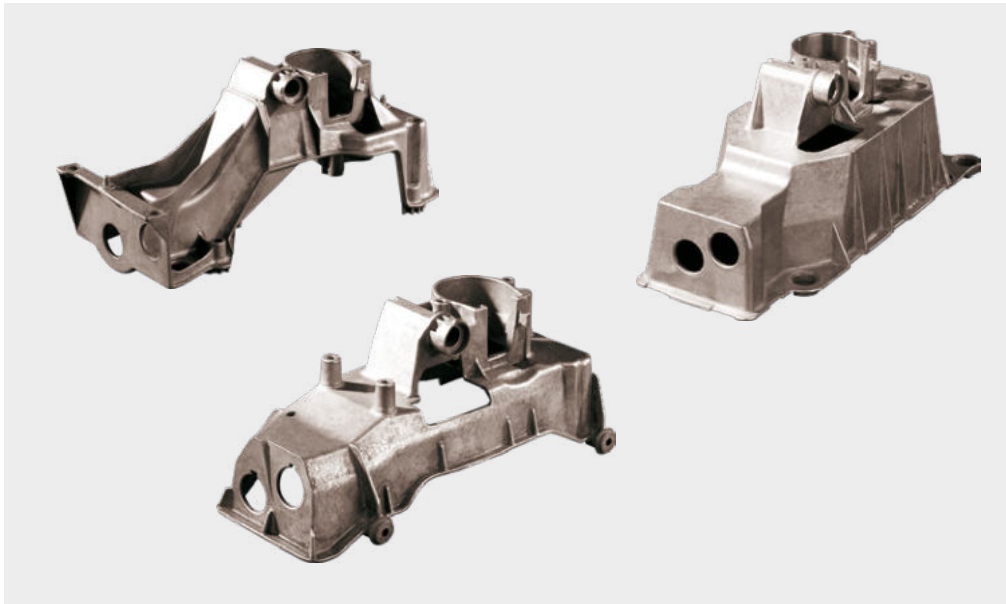

Schalthebelgehäuse

Werkstoff: Mg

Gear lever case

Material: magnesium

齿轮手柄壳

材料: 镁合金



Ausgleichsgewicht

Werkstoff: GG

Counter balance weight

Material: gray cast iron

配重件

材料: 灰铸铁



Fußhebellagerwerk

Werkstoff: Al

Pedal console

Material: aluminum

踏板控制台

材料: 铝合金

Automotive – Automotive – 汽车行业

Motor – Engine – 发动机

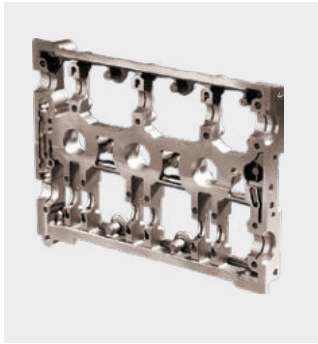

**Leiterrahmen für
Nockenwellenlagergehäuse**

Werkstoff: Al

Engine bulkhead housing

Material: aluminum

发动机隔离罩

材料: 铝合金

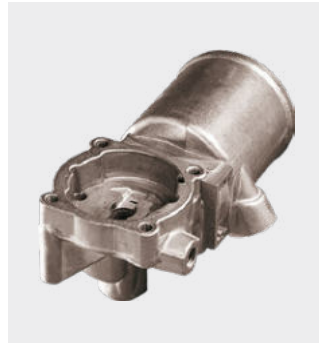

**Gehäuse für
Flügelzellenpumpe**

Werkstoff: Al

Body for vane-type pump

Material: aluminum

叶轮泵壳体

材料: 铝合金

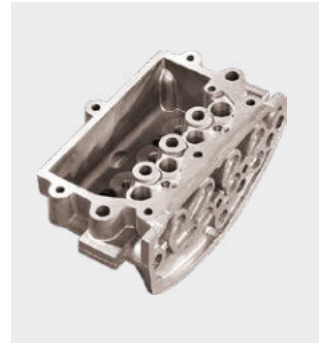

Gehäuse

Werkstoff: Al

Housing

Material: aluminum

壳体

材料: 铝合金



Zahnradpumpegehäuse

Werkstoff: Al

Gear pump housing

Material: aluminum

齿轮泵壳体

材料: 铝合金



Ölpumpegehäuse

Werkstoff: Al

Oil pump housing

Material: aluminum

机油泵壳

材料: 铝合金



Ölpumpendeckel

Werkstoff: Al

Oil pump cover

Material: aluminum

机油泵盖

材料: 铝合金



Kipphebel

Werkstoff: St

Rocker arm

Material: steel

摇臂

材料: 钢

Automotive – Automotive – 汽车行业

Motor – Engine – 发动机

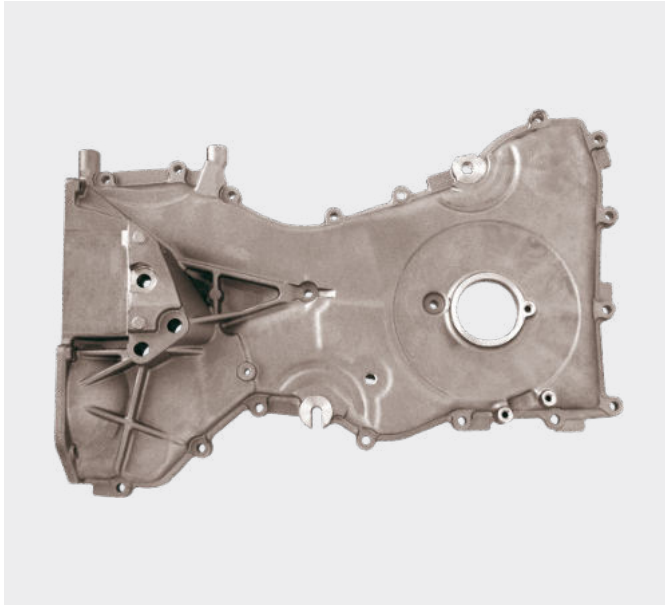

Stirndeckel

Werkstoff: Al

Front cover

Material: aluminum

前盖

材料: 铝合金



Ventilgehäuse

Werkstoff: GGG

Valve housing

Material: gray cast iron

阀体

材料: 灰铸铁



Kurbelwellenlagerdeckel

Werkstoff: GGG

Crank shaft bearing cap

Material: gray cast iron

曲轴轴承盖

材料: 灰铸铁



Wasserpumpe

Werkstoff: GG

Water pump

Material: gray cast iron

水泵

材料: 灰铸铁



Dichtflansch

Werkstoff: Al

Gasket flange

Material: aluminum

垫片法兰

材料: 铝合金



Dichtflansch, hinten

Werkstoff: Al

Seal flange, rear

Material: aluminum

后端密封法兰

材料: 铝合金

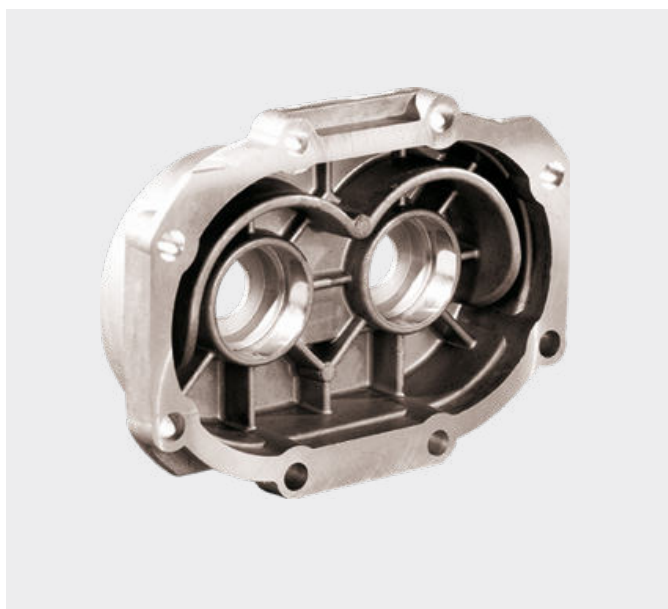

Kompressorlagerdeckel

Werkstoff: Al

Bearing cover

Material: aluminum

轴承罩

材料: 铝合金



Kompressorgehäuse

Werkstoff: Al

Turbocharger Housing

Material: aluminum

涡轮增压器壳

材料: 铝合金



Ölfilterhalter

Werkstoff: Al

Oil filter support

Material: aluminum

油滤器支架

材料: 铝合金

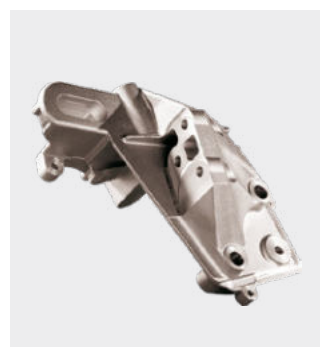

Motorhalter

Werkstoff: Al

Combi bracket

Material: aluminum

复合支架

材料: 铝合金



Nockenwellenlagerdeckel

Werkstoff: Al

Camshaft bearing cover

Material: aluminum

凸轮轴轴承盖

材料: 铝合金



Antriebslager

Werkstoff: Al

Bearing end shield

Material: aluminum

轴承护罩

材料: 铝合金

Automotive – Automotive – 汽车行业

Motor – Engine – 发动机

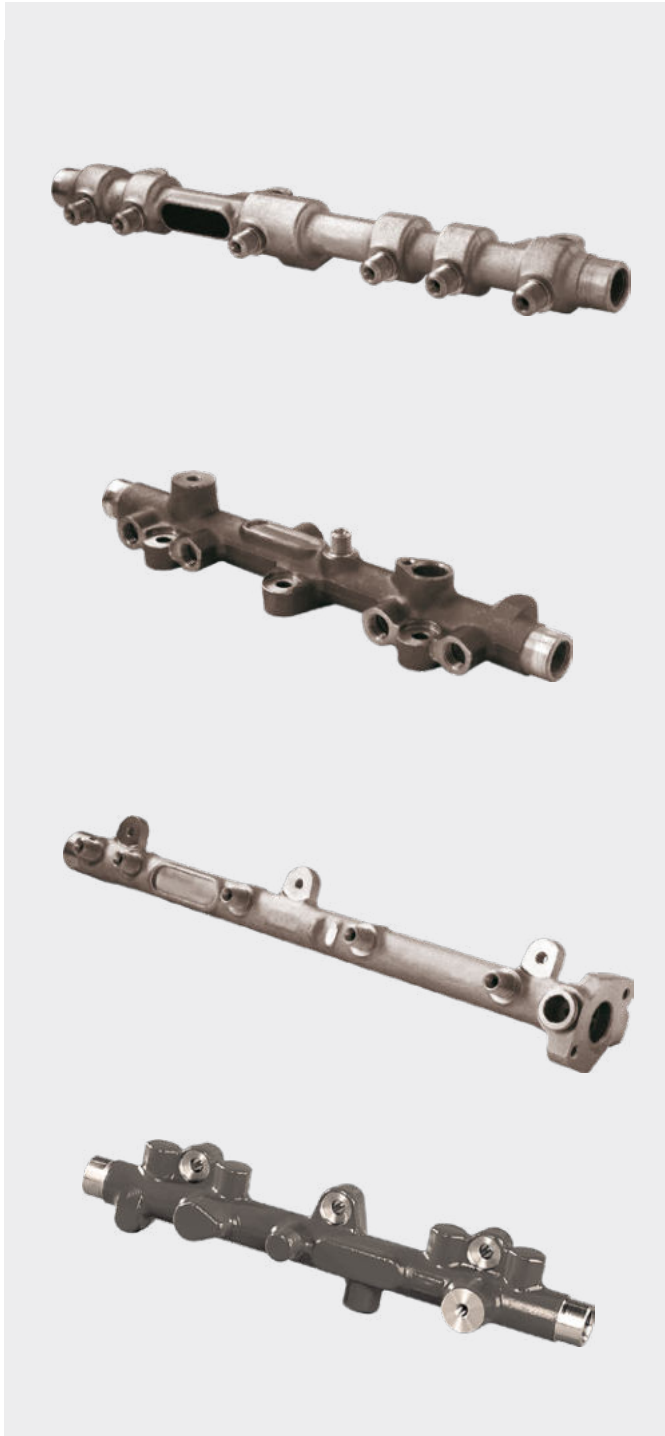

Common Rail

Werkstoff: St

Common rail

Material: steel

共轨管

材料: 钢

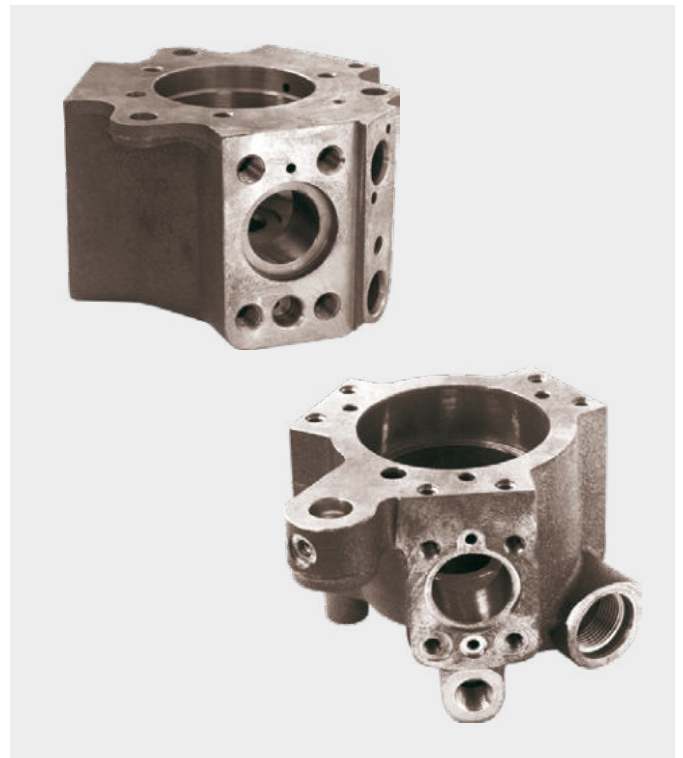

Pumpengehäuse Common Rail

Werkstoff: GGG

Pump casing for diesel injection

Material: gray cast iron

柴油喷射泵壳

材料: 灰铸铁

Automotive – Automotive – 汽车行业

Motorrad – Motorcycle – 摩托车

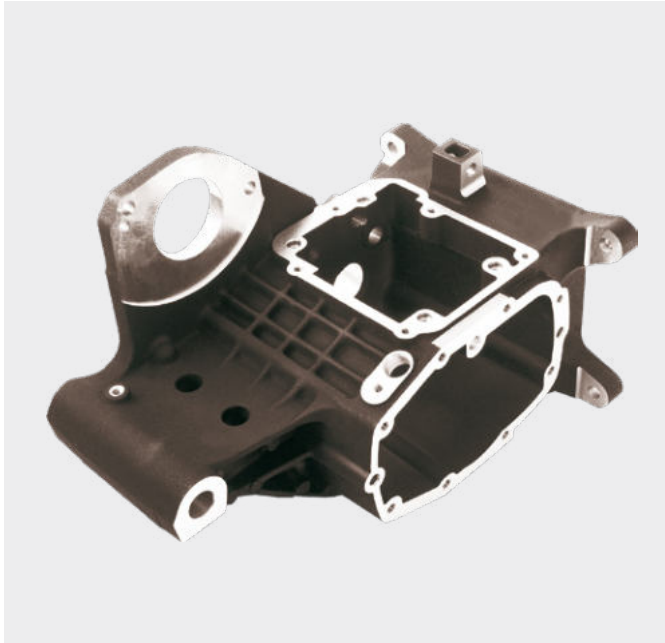

Getriebegehäuse

Werkstoff: Al

Transmission case

Material: aluminum

变速箱壳体

材料: 铝合金



Zylinderkopf

Werkstoff: Al

Cylinder head

Material: aluminum

缸盖

材料: 铝合金



Kurbelgehäuse

Werkstoff: Al

Crank case

Material: aluminum

曲轴箱体

材料: 铝合金

Automotive – Automotive – 汽车行业

E-Antrieb – E-drives – 电动汽车

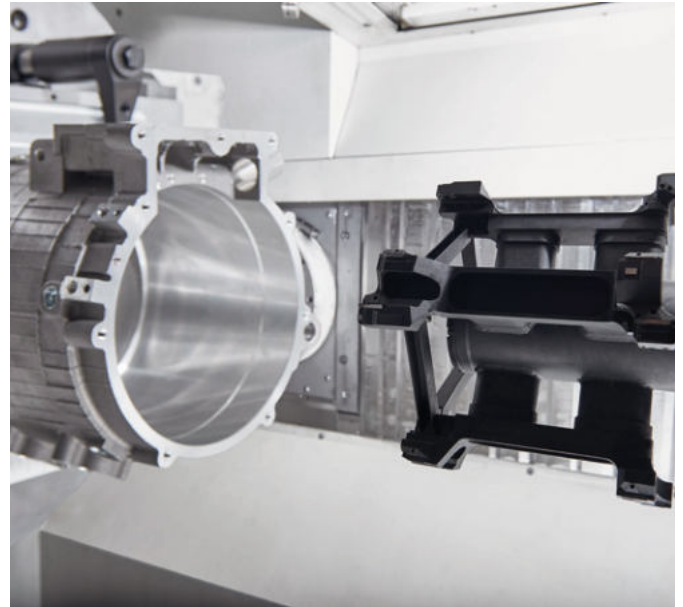

E-Motor Gehäuse

Werkstoff: Aluminium / Guß

E drive housing

Material: aluminium / cast iron

新能源电机壳

材料: 铝/铸铁



Stecker

Werkstoff: Kupfer, Messing (bleifrei)

Plugs

Material: cooper, brass (lead free)

接头

材料: 紫铜/黄铜 (无铅)

Armaturen / Sanitär – Faucet / Fittings – 水暖行业

Gebäudeinstallation – Plumbing – 管道设备



Doppelpumpengehäuse

Werkstoff: GG

Double pump housing

Material: gray cast iron

双泵壳体

材料: 灰铸铁

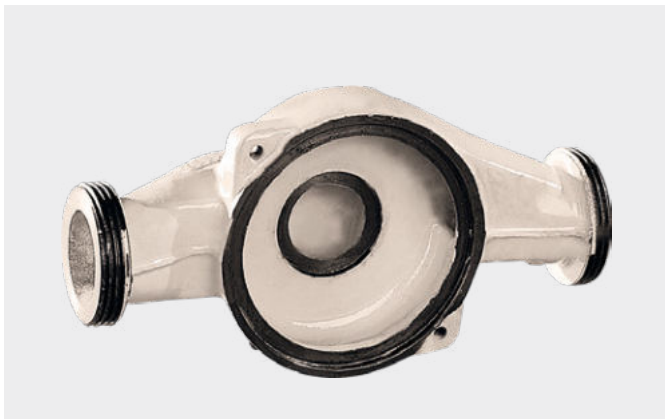

Pumpengehäuse

Werkstoff: GG

Pump housing

Material: gray cast iron

泵壳

材料: 灰铸铁



Ventilgehäuse

Werkstoff: GJMB

Valve housing

Material: malleable iron

阀体

材料: 锻钢



Pumpengehäuse

Werkstoff: GG

Pump housing

Material: gray cast iron

泵壳

材料: 灰铸铁



Armaturengehäuse

Werkstoff: GG

Armature housing

Material: gray cast iron

转子外壳

材料: 灰铸铁

Armaturen / Sanitär – Faucet / Fittings – 水暖行业

Fittings – Fittings – 管件

Zerspanen und Umformen in der gleichen Maschine – in einer Aufspannung

Cutting and forming in one machine – in one set-up

在一台机床中加工和成型 – 一次装夹



Press-Fittings (Muffen)

Werkstoff: Edelstahl

Fittings (coupling)

Material: stainless steel

管件(管箍)

材料: 不锈钢



Press-Fittings (Bögen)

Werkstoff: Edelstahl

Fittings (elbow)

Material: stainless steel

管件

材料: 不锈钢



Press-Fittings (T-Stücke)

Werkstoff: Edelstahl

Fittings (tee)

Material: stainless steel

管件(三通)

材料: 不锈钢



Press-Fittings (T-Stücke)

Werkstoff: Cu

Fittings (tee)

Material: copper

管件(三通)

材料: 铜



Löt-Fittings

Werkstoff: Cu

Fittings

Material: copper

管件

材料: 铜



Press-Fittings (Bögen)

Werkstoff: Cu

Fittings (elbow)

Material: copper

管件(弯管)

材料: 铜



Verteiler Wandabschluss

Werkstoff: Ms

Distribution device

Material: brass

管件

材料: 黄铜



Gasventil

Werkstoff: Ms

Gas valve

Material: brass

燃气阀

材料: 黄铜



Fittings

Werkstoff: Ms

Fittings

Material: brass

管件(弯管)

材料: 黄铜

Armaturen / Sanitär – Faucet / Fittings – 水暖行业

Mischarmaturen – Faucets – 水龙头



Einhandmischer

Werkstoff: Ms

Single lever faucet

Material: brass

单柄龙头

材料: 黄铜



Zweigriffarmatur

Werkstoff: Ms

Two handle faucet

Material: brass

双柄龙头

材料: 黄铜

Mischarmatur

Werkstoff: Ms

Two handle faucet

Material: brass

双柄龙头

材料: 黄铜



Thermostatgehäuse

Werkstoff: Ms

Thermostat housing

Material: brass

节温器壳体

材料: 黄铜

Armaturen / Sanitär – Faucet / Fittings – 水暖行业

Verschraubungen – Screw fittings – 螺纹连接件



T-Stück

Werkstoff: Ms

Tee

Material: brass

三通

材料: 黄铜



Winkel-Anschlussstück

Werkstoff: Ms

90° adapter fitting

Material: brass

90° 转接弯头

材料: 黄铜



Verschraubung

Werkstoff: St

Tee

Material: steel

三通

材料: 钢



Verschraubung

Werkstoff: Ms (bleifrei)

Reducer

Material: brass (lead free)

异径管接头

材料: 黄铜 (无铅)



Armaturengehäuse

Werkstoff: Ms

Armature housing

Material: brass

转子壳体

材料: 黄铜



Gasflaschenventil

Werkstoff: Ms

Gas bottle valve

Material: brass

燃气管阀

材料: 黄铜



Schrägsitzventil

Werkstoff: Ms

Angular valve

Material: brass

角向阀

材料: 黄铜



Verschraubung

Werkstoff: St

90° elbow

Material: steel

90°弯头

材料: 钢

Armaturen / Sanitär – Faucet / Fittings – 水暖行业

Verteilergehäuse – Manifold housings – 歧管



Zylinderkopf für Hochdruckreiniger

Werkstoff: Ms

Cylinder head for high-pressure cleaner

Material: brass

高压清洁器缸头

材料: 黄铜



Verteiler Wandabschluss

Werkstoff: Ms

Distributor

Material: brass

分配器

材料: 黄铜



Verteiler

Werkstoff: Ms

Water mixing valve

Material: brass

混水阀

材料: 黄铜



Armaturenformstück

Werkstoff: Ms

Valve

Material: brass

阀

材料: 黄铜

Industrial Equipment – Other industry branches – 工业设备

Baumaschinen / Mobilhydraulik – Construction equipment / Mobile Hydraulic –
建筑设备 / 移动液压



Kettenglieder

Werkstoff: St

Chain links

Material: steel

链节

材料: 钢



Hydraulikpumpengehäuse

Werkstoff: GG

Hydraulic pump housing

Material: gray cast iron

液压泵壳体

材料: 灰铸铁



Ventilgehäuse

Werkstoff: Edelstahl

Valve housing

Material: stainless steel

阀壳体

材料: 不锈钢



Filterkopf für Baumaschinen

Werkstoff: GG

Filter head for construction machines

Material: gray cast iron

建筑设备过滤器头

材料: 灰铸铁

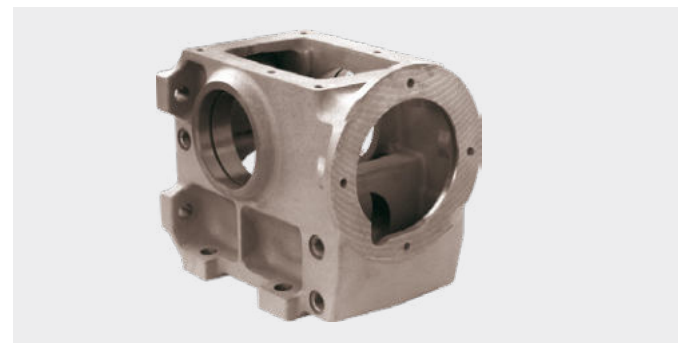

Getriebegehäuse

Werkstoff: GG

Gear box housing

Material: gray cast iron

齿轮箱

材料: 灰铸铁

Industrial Equipment – Other industry branches – 工业设备

Waschmaschine – Washing machines – 洗衣机

Kompressoren – Compressors – 压缩机

Türschließgehäuse – Door lock housings – 闭门器

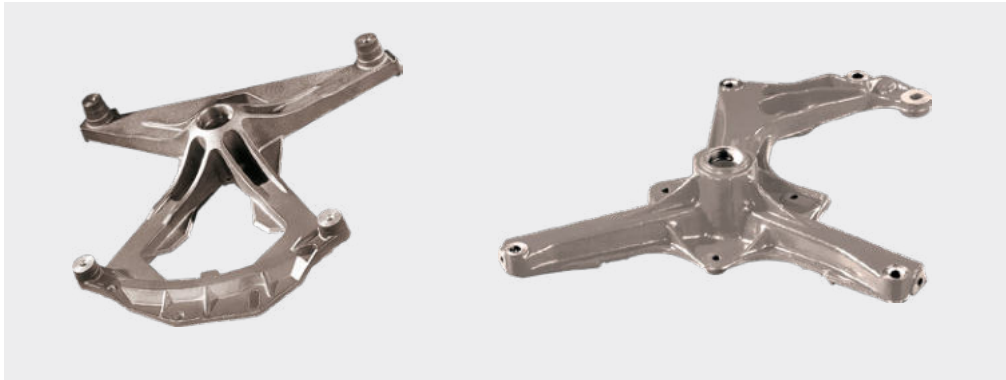

Waschmaschinen-Lagerkreuz

Werkstoff: GG

Cast bracket for washing machine drum

Material: gray cast iron

洗衣机滚筒支架

材料: 灰铸铁



Ausgleichsgewicht

Werkstoff: GG

Balancing weight

Material: gray cast iron

配重

材料: 灰铸铁



Kompressorgehäuse für Transportkühlanlagen

Werkstoff: Al

Compressor housing

Material: aluminum

压缩机壳体

材料: 铝合金



Kühlschrank-Kompressorgehäuse

Werkstoff: GG

Compressor housing refrigerator

Material: gray cast iron

冰箱压缩机缸体

材料: 灰铸铁



Türschließgehäuse

Werkstoff: GG

Door lock housings

Material: gray cast iron

闭门器壳体

材料: 灰铸铁



Türschließgehäuse

Werkstoff: Al

Door lock housing

Material: aluminum

闭门器壳体

材料: 铝合金

Industrial Equipment – Other industry branches – 工业设备

Zapfhahngehäuse – Fuel filler nozzle housing – 加油器喷嘴壳体

Werkzeug – Tools – 工具

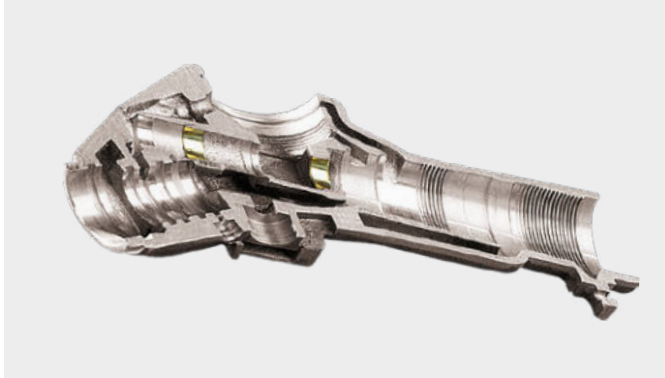

Treibstoff-Zapfhahngehäuse

Werkstoff: Al

Fuel filler nozzle housing

Material: aluminum

燃气过滤嘴壳体

材料: 铝合金



Kombizange

Werkstoff: St

Universal pliers

Material: steel

通用钳子

材料: 钢



Lagerschild für Bohrmaschine

Werkstoff: Al

Bearing support for hammer drill

Material: aluminum

冲击钻轴承座

材料: 铝合金



Getriebegehäuse für Bohrmaschine

Werkstoff: Al

Gear housing for hammer drill

Material: aluminum

冲击钻齿轮壳

材料: 铝合金

Fräsen – Mehrwegetechnologie

Multi-way milling technology

多路径铣削技术

Witzig & Frank bietet eine große Bandbreite an Lösungen für die Volumenfertigung – vom klassischen, hochproduktiven Transfersystem bis zu flexiblen Mehrstationen- und Mehrspindelbearbeitungszentren. Das Anwendungsspektrum reicht vom Automobil-Antriebsstrang über Sanitär-Armaturen, Komponenten für Baumaschinen, Elektromotoren, aber auch Waschmaschinen oder Handwerkzeuge. Das Technologie-, Turnkey- und Anlagen-Knowhow von Witzig & Frank umfasst eine große Auswahl an Bearbeitungstechnologien, Spannmitteln, Automationslösungen, Antriebs- und Steuerungsvarianten.

Witzig & Frank offers a broad range of equipment and technologies for volume production – from proven, highly productive transfer systems to flexible multi-station, multi-spindle machining centers. Applications include automotive powertrain components, faucet, fittings, construction equipment, electrical engines, as well as household equipment and hand tools.

Witzig & Frank's technology, turnkey and systems knowhow comprises various machining technologies, clamping and fixturing variants, automation and workpiece handling as well as control and drive options.

Witzig & Frank 为大批量生产提供多种设备和技术—从经过验证, 高效的自动线系统到柔性多工位、多主轴加工中心。应用包括汽车动力总成零部件、球笼、管接头件、建筑设备、电动发动机, 以及家用设备和手动工具。Witzig & Frank的技术, 交钥匙和系统专有技术包括各种加工技术, 装夹和夹具变型, 自动化和工件装卸以及控制和驱动器选项。

Maschinenkonzepte

- ▶ TURMAT – Mehrwege-Rundtransfermaschine
- ▶ LSA – Mehrwege-Fertigungszelle mit horizontaler Schaltachse
- ▶ TRIFLEX – Modulares Mehrstationen-Bearbeitungszentrum
- ▶ TWINFLEX – mehrspindliges Zweistationen-CNC-Bearbeitungszentrum

Machine models

- ▶ TURMAT – Multi-way rotary transfer machine – vertical
- ▶ LSA – Multi-way manufacturing cell – horizontal
- ▶ TRIFLEX – Modular multi-station machining center
- ▶ TWINFLEX – two-station multi-spindle machining center

模块化机床

- ▶ TURMAT – 多工位回转自动线
- ▶ LSA – 多路径制造单元
- ▶ TRIFLEX – 模块化,多工位加工中心,一次装夹5面加工
- ▶ TWINFLEX – 多主轴双工位加工中心

Technologieanwendungen –

Technology examples – 应用案例

Witzig & Frank Maschinen sind mit einer großen Auswahl an Bearbeitungseinheiten optimal für die Komplettbearbeitung ausgelegt.

Witzig & Frank machines are ideally suited for integrated machining solutions.

Witzig & Frank机床是理想的集成加工解决方案



Witzig & Frank online Video
维茨希·弗兰克在线视频

Fräsen

Milling

铣削



Bohren

Drilling

钻削



Räumen

Broaching

拉削



Innen Ausdrehen

Inside turning

内圆车削

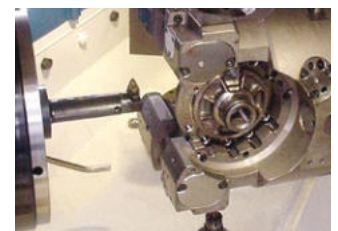

Anwendungsbereiche

Application range

工业应用

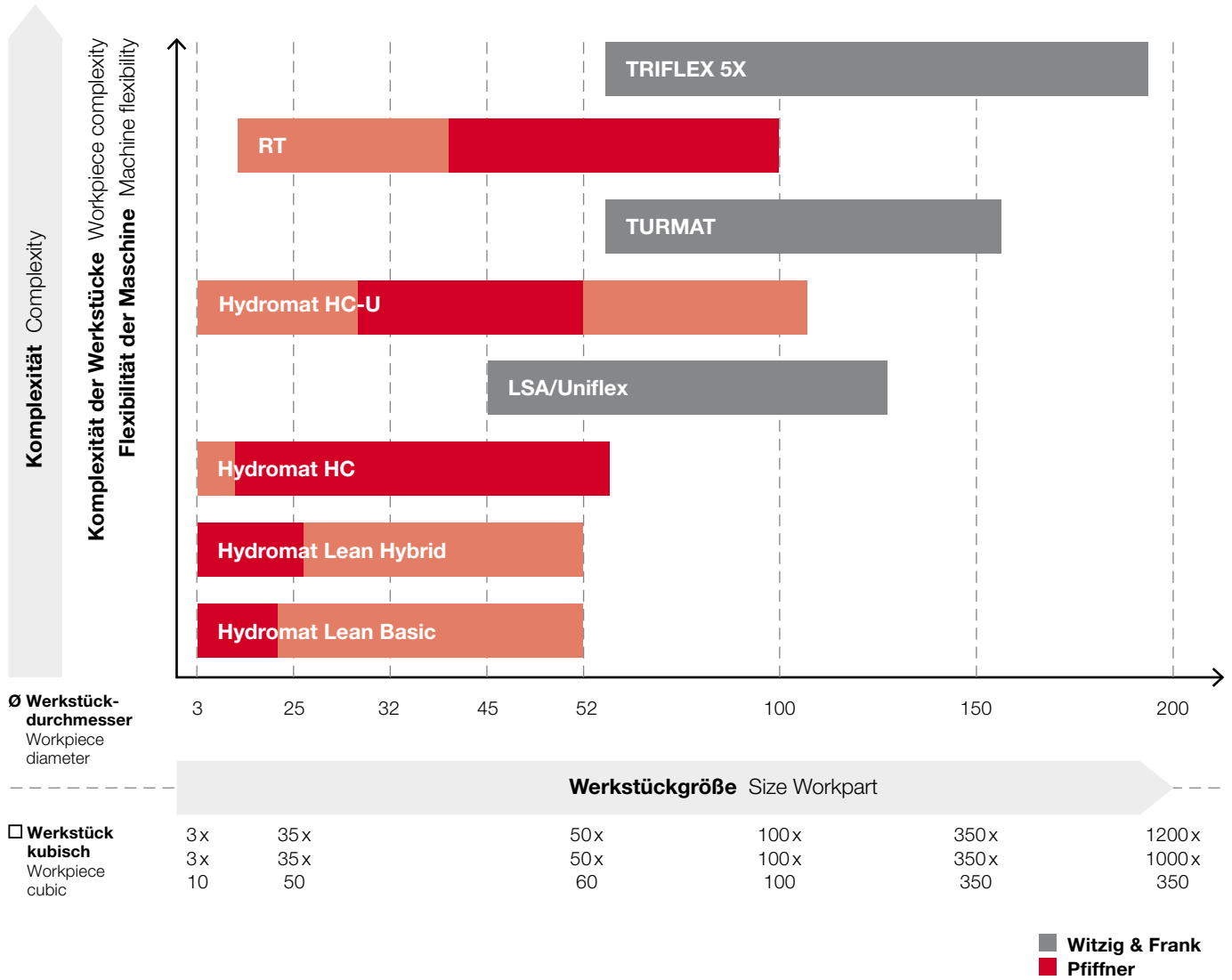

Zirkular Gewinden

Threading

螺纹



Aussteuerwerkzeuge

Draw bar tools

拉杆刀具

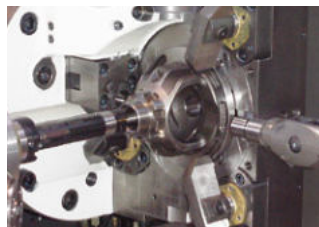

Büchsen Einpressen

In-process bush pressing

同期衬套压装



Hontechnik

Honing technology

珩磨技术



Service and Support

WITZIG & FRANK Services

We offer professional services for your highly productive machines and plants. Whether it's a matter of keeping the availability of your plants as high as possible or adapting them in line with necessary changes in order to continue producing products at a high level. As your partner, we want to use our know-how to help us to be successful together.

- ▶ **Hotline / Remote service**
- ▶ **Inspection**
- ▶ **Repairs**
- ▶ **Process optimization (OEE)**
- ▶ **Spare parts**
Top quality and maximum lifetime with original Witzig & Frank spare parts
- ▶ **Retooling**

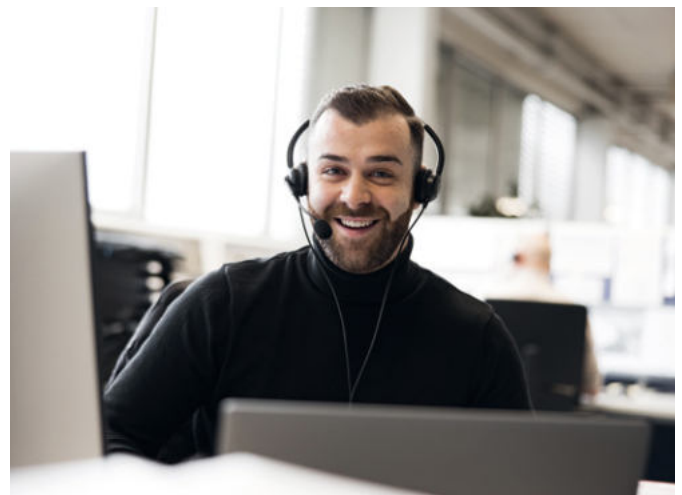

Service Products

Investment where it really pays off

- ▶ **Exchange assemblies**
- ▶ **Retrofit kit/remote access**
- ▶ **Replacement assemblies for quick on-site exchange**
- ▶ **Service agreements**
- ▶ **Training**
- ▶ **Revest®**
The rejuvenation treatment for your Witzig & Frank transfer machines

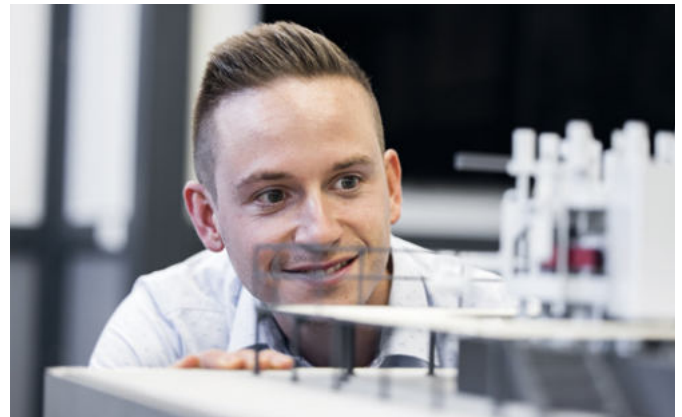

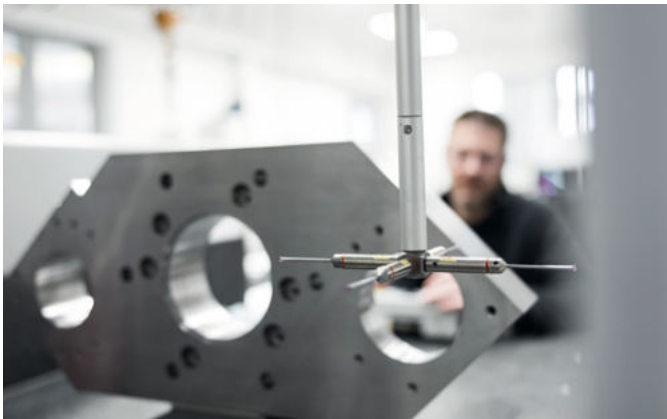

Germany

Witzig & Frank / K.R. Piffner GmbH
Am Holderstock 2
DE-77652 Offenburg
Tel.: +49 781 289 0
Fax: +49 781 289 1303
www.witzig-frank.com

Service/Parts Hotline/Website

Tel.: +49 781 289 1000
service@witzig-frank.com



USA

MAG Automotive LLC
6015 Center drive
US-MI 48312 Sterling Hights
Tel.: +1 586 446 7000
Fax: +1 586 335 4490

Service/Parts Hotline/Website

Tel.: +1 888 858 9920
MAG-Automotive.Serviceparts@mag-ias.com



Über FFG Europe & Americas

FFG Europe & Americas vereint große Traditionen der deutschen, italienischen, schweizerischen und amerikanischen Werkzeugmaschinenindustrie in einer Gruppe und bietet mit den Marken VDF Boehringer, Hessapp, Jobs, MAG, Meccanodora, Modul, Morara, Pfiffner, Rambdaudi, Sachman, Sigma, SMS, Tacchella und Witzig & Frank ein herausragendes Portfolio an Dreh-, Fräs-, Schleif- und Verzahnmaschinen und eine einzigartige Know-how-Basis. Seit 1798 tragen diese Marken zum Fortschritt in der Produktionstechnik bei und gelten heute als zuverlässige und innovative Ausrüster für die Automobil- und Nutzfahrzeugindustrie, die Luft- und Raumfahrt, den Maschinenbau, die Metallverarbeitung, die Schienenverkehrstechnik, die Energietechnik und die Schwerindustrie. Als eigenständige Einheit profitieren die Premiumhersteller im Verbund der FFG-Unternehmen von der Größe und den Möglichkeiten der globalen Gruppe.

About FFG Europe & Americas

The FFG entities in Europe and the Americas unite major players from the German, Italian, Swiss and American machine tool industry with a broad range of milling, turning, grinding, and gear manufacturing technology, and the knowhow of the renowned machine tool brands VDF Boehringer, Hessapp, Jobs, MAG, Meccanodora, Modul, Morara, Pfiffner, Rambdaudi, Sachman, Sigma, SMS, Tacchella and Witzig & Frank. Since 1798, these brands have substantially contributed to the progress in industrial manufacturing and are well known as reliable and innovative equipment and systems solutions suppliers for the automotive and truck, aerospace, machine building, general machining, railway industry, energy and heavy engineering industries. While being an independent group, these entities benefit from the strengths and opportunities of the global Fair Friend Group. They stand for premium technology within FFG.

关于FFG欧美集团

FFG欧美集团作为技术领先的机床集团，拥有众多知名品牌：VDF Boehringer（柏林格爾）、Hessapp（海瑟普）、Jobs（乔布斯）、MAG、Meccanodora（麦克诺朵拉）、MODUL（模德）、Morara（莫罗拉）、Pfiffner（佩非勒）、Rambdaudi（蓝苞蒂）、Sachman（萨克曼）、SIGMA（西格玛）、SMS、Tacchella（塔凯拉）及Witzig & Frank（维茨希·弗兰克）等。作为杰出的技术集成商和设备制造商，我们以完美的工艺技术及在此基础上量身定做的生产解决方案而闻名。拥有丰富的产品线及技术，包括铣削、车削、磨削、齿轮加工技术、系统集成、复合材料加工、维修、工控系统及软件、核心零部件等。自1798年以来，FFG欧美集团旗下各大品牌不断推动着世界工业制造业的发展与进步，广泛服务于航空航天、汽车、重型机械、能源、轨道交通、机床制造及通用加工等行业。作为独立的实体公司，同时又隶属于全球友嘉（FFG）实业集团，FFG欧美集团各品牌受益于友嘉集团的强大实力及资源，并代表友嘉集团最先进的技术。

K.R. Pfiffner AG

Sonnmattstrasse 28
CH-3427 Utzenstorf
Tel.: +41 32 666 35 35
Fax: +41 32 666 35 55
www.pfiffner.com

Witzig & Frank / K.R. Pfiffner GmbH

Am Holderstock 2
DE-77652 Offenburg
Tel.: +49 781 289 0
Fax: +49 781 289 1303
www.witzig-frank.com

FFG Europe & Americas

info@ffg-ea.com

www.ffg-ea.com