



# Maschinen von Witzig & Frank fertigen auch Ihr Werkstück

Your workpiece – produced by machines of Witzig & Frank

你的工件 – 在Witzig & Frank机床上加工

**Witzig & Frank** entwickelt und baut hochproduktive Anlagen für die Produktion kleiner bis mittelgroßer Bauteile in der Sanitär- und Armaturenindustrie, dem Automobil- und Maschinenbau. Unsere Leistungen umfassen die Prozessentwicklung anhand des Kundenwerkstücks, die Integration von Zusatztechnologien sowie die Auslegung und Umsetzung von Turnkey-Anlagen durch erfahrene Ingenieure. Unsere in Deutschland gefertigten Anlagen exportieren wir in alle Industrienationen und unterstützen unsere Kunden durch zuverlässigen Service über den kompletten Produktionszyklus sowie Ingenieursdienstleistungen wie Umbauten und Retrofits.

**Witzig & Frank** is the leading brand for highly productive manufacturing systems in the Faucet and Fittings, Automotive, and Industrial Equipment industries for small to medium sized parts. Our approach includes work piece dedicated application, the integration of multiple technologies and turnkey system development and design, handled by experienced engineers. We manufacture in Germany and deliver our solutions to all industrialized nations, providing maintenance, service and support during the entire machine life cycle, including retooling, retrofit and service contracts

**Witzig & Frank**是为汽车行业，水暖行业，以及其它工业领域提供中小工件高效制造系统的领先品牌。我们的方法包括工件的专用的应用程序，多种工艺技术综合和交钥匙工程的开发与设计，这些都由经验丰富的工程师处理。我们制造在德国，为所有的工业化国家提供我们的解决方案，并且在整个设备生命周期内提供维修服务和技术支持，包括重组工装，翻新改造和服务合同。

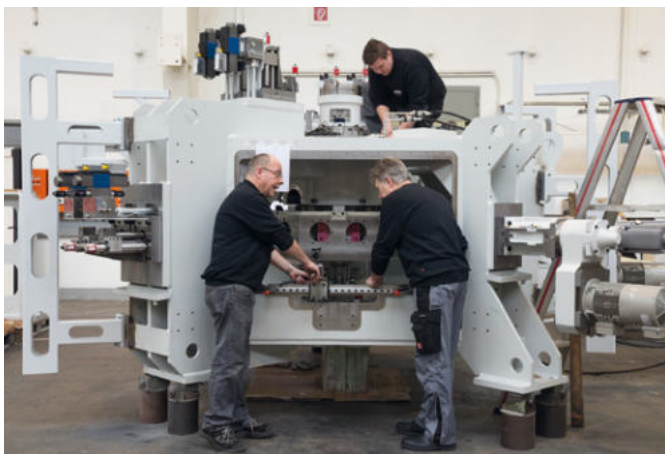
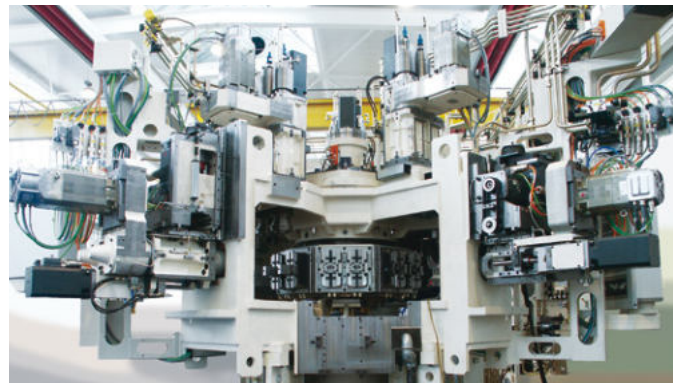

# Eine Auswahl an Werkstücken, die bisher auf Witzig & Frank-Maschinen bearbeitet wurden

A collection of workpieces produced on Witzig & Frank machines

Witzig & Frank 机床加工的典型工件

## Automotive

Automotive  
汽车行业

- ▶ Achse – Axle – 车桥 ..... 4
- ▶ Bremse – Brake – 制动 ..... 6
- ▶ Getriebe – Transmission – 变速箱 ..... 7
- ▶ Differential – Differential – 差速器 ..... 9
- ▶ Lenkung – Steering – 转向器 ..... 10
- ▶ Innenraum – Interior – 内饰件 ..... 12
- ▶ Motor – Engine – 发动机 ..... 13
- ▶ Motorrad – Motorcycle – 摩托车 ..... 17
- ▶ E-Antrieb – E-drives – 电动汽车 ..... 18



Automotive – Automotive – 汽车行业

## Armaturen/Sanitär

Faucet/Fittings  
水暖行业

- ▶ Gebäudeinstallation – Plumbing – 管道设备 ..... 19
- ▶ Fittings – Fittings – 管件 ..... 20
- ▶ Mischarmaturen – Faucets – 水龙头 ..... 22
- ▶ Verschraubungen – Screw fittings – 螺纹连接件 ..... 23
- ▶ Verteilergehäuse – Manifold housings – 歧管 ..... 24

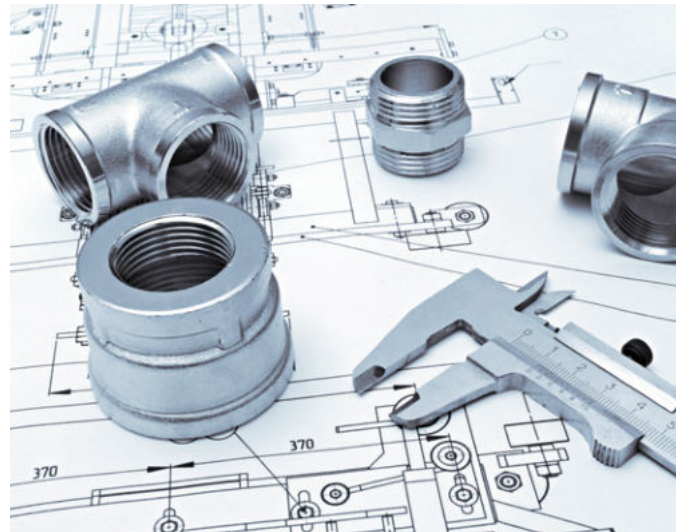

Armaturen/Sanitär – Faucet/Fittings – 水暖行业

## Industrial Equipment

Other industry branches  
工业设备

- ▶ Baumaschinen – Construction equipment – 建筑设备 ..... 25
- ▶ Waschmaschine – Washing machines – 洗衣机 ..... 26
- ▶ Kompressoren – Compressors – 压缩机 ..... 26
- ▶ Türschließgehäuse – Door lock housings – 闭门器 ..... 26
- ▶ Zapfhahngehäuse – Fuel filler nozzle housing – 加油器喷嘴壳体 ..... 27
- ▶ Werkzeug – Tools – 工具 ..... 27



Industrial Equipment – Other industry branches – 工业设备

# Automotive – Automotive – 汽车行业

## Achse – Axle – 车桥

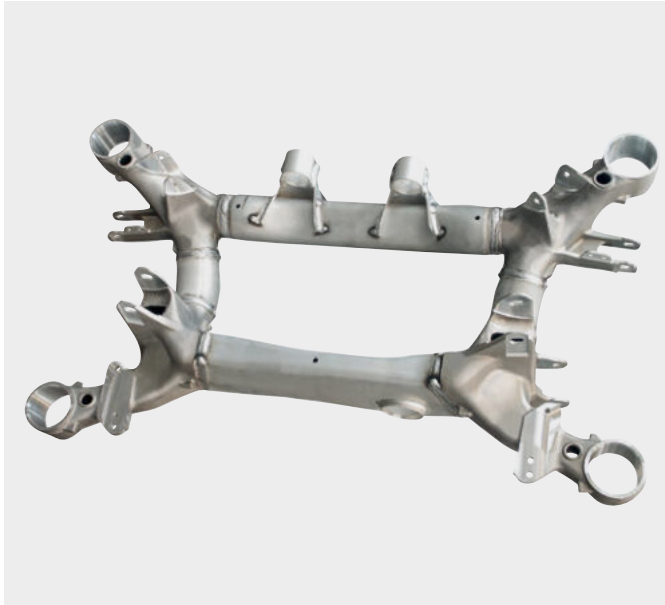

### Hinterachsträger

Werkstoff: Al

#### Cast joint

Material: aluminum

#### 铸造链接件

材料: 铝合金



### Gussknoten

Werkstoff: Al

#### Cast joint

Material: aluminum

#### 铸造链接件

材料: 铝合金



### Achsträger vorn

Werkstoff: Al

#### Leading cross member

Material: aluminum

#### 引导横梁

材料: 铝合金



### Armgehäuse

Werkstoff: Al

#### Arm case

Material: aluminum

#### 摇臂

材料: 铝合金

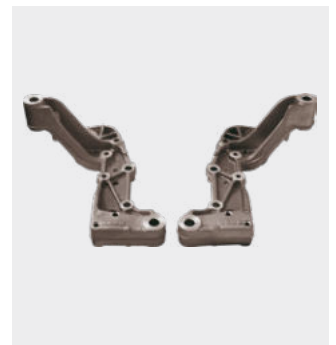

### Konsole (paarweise gespannt)

Werkstoff: Al

#### Bracket (clamped set)

Material: aluminum

#### 支架(卡紧组件)

材料: 铝合金



**Schwenklager**

Werkstoff: GG

**Knuckle**

Material: gray cast iron

**转向节**

材料:灰铸铁



**Achsträger**

Werkstoff: GG

**cross member**

Material: gray cast iron

**转向节**

材料:灰铸铁

# Automotive – Automotive – 汽车行业

## Bremse – Brake – 制动



### Traverse

Werkstoff: St

### Traverse

Material: steel

### 横盖

材料: 钢



### Bremssattel

Werkstoff: GG

### Calliper

Material: gray cast iron

### 卡尺

材料: 灰铸铁



### Radbremsszylinder

Werkstoff: GG

### Wheel brake cylinder

Material: gray cast iron

### 车轮油缸

材料: 灰铸铁



### Gehäuse für Bremshydraulik

Werkstoff: GG

### Hydraulic brake housing

Material: gray cast iron

### 车轮油缸

材料: 灰铸铁

# Automotive – Automotive – 汽车行业

## Getriebe – Transmission – 变速箱

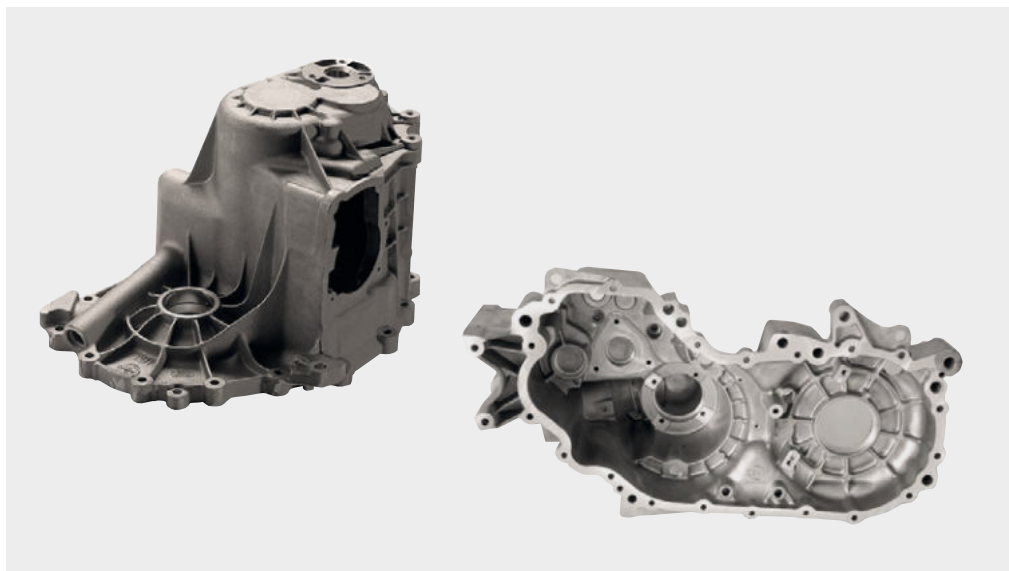

### Getriebegehäuse

Werkstoff: Al

### Gear box

Material: aluminum

### 齿轮箱

材料: 铝合金

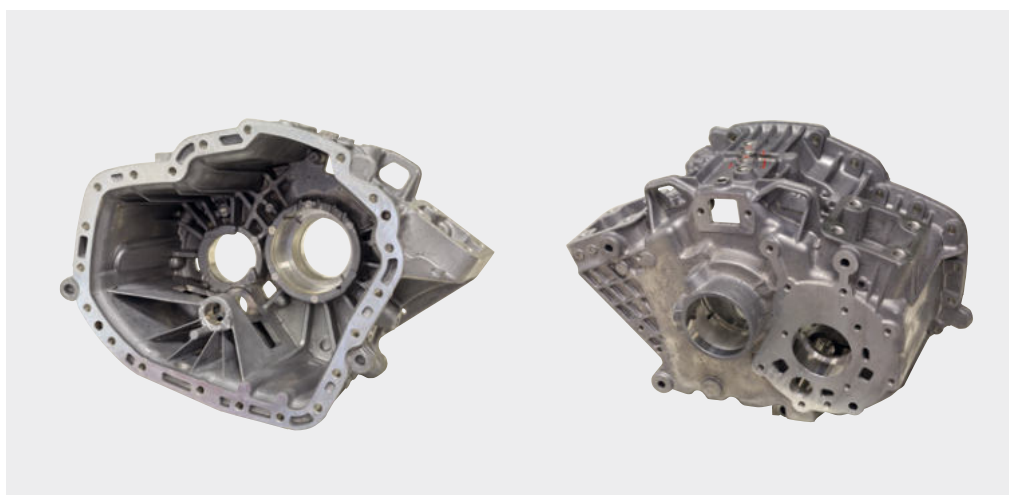

### Kupplungsgehäuse

Werkstoff: Mg

### Clutch housing

Material: magnesium

### 离合器壳体

材料: 镁合金

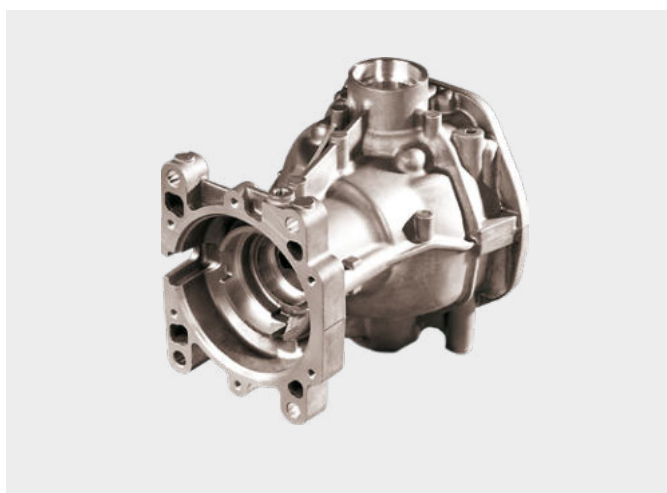

### Hinterachsgetriebegehäuse

Werkstoff: Al

### Rear axle transmission housing

Material: aluminum

### 差速器壳支撑

材料: 铝合金

# Automotive – Automotive – 汽车行业

## Getriebe – Transmission – 变速箱



### Primärpumpe

Werkstoff: GG

### Primary pump

Material: gray cast iron

### 初级泵

材料: 灰铸铁



### Ölpumpengehäuse

Werkstoff: Al

### Oil pump housing

Material: aluminum

### 油泵壳体

材料: 铝合金



### Antriebswelle

Werkstoff: GG

### Reactor shaft

Material: gray cast iron

### 响应轴

材料: 灰铸铁



### Planetenträger vorn

Werkstoff: Al

### Pinion gear cage

Material: Al

### 主动齿轮笼

材料: 铝合金

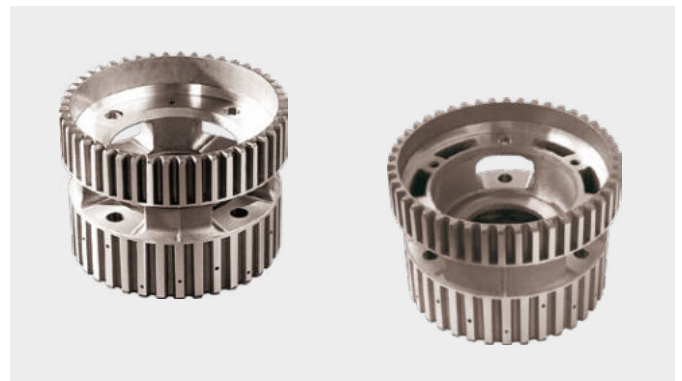

### Planetenträger hinten

Werkstoff: Al

### Pinion gear cage, rear set

Material: aluminum

### 主动齿轮笼, 后组

材料: 铝合金

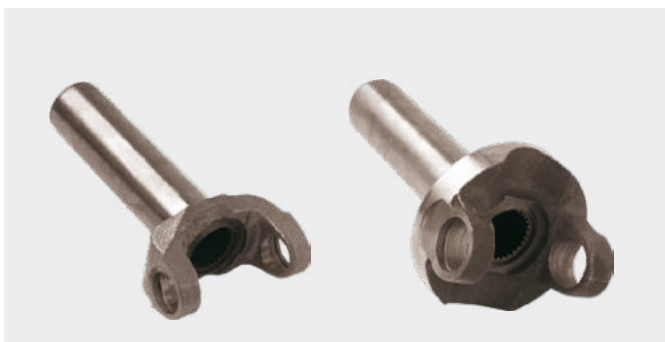

### Gelenkgabel

Werkstoff: GJMB

### Yoke

Material: malleable Iron

### 支座

材料: 可锻铸铁



# Automotive – Automotive – 汽车行业

## Differential – Differential – 差速器



### Differentialgehäuse

Werkstoff: GGG

### Differential housing

Material: gray cast iron

### 差速器壳体

材料: 灰铸铁



### Differentialgehäuse

Werkstoff: GJMB

### Differential housing

Material: malleable iron

### 差速器壳体

材料: 可锻铸铁

# Automotive – Automotive – 汽车行业

## Lenkung – Steering – 转向器



**Lenkgehäuse - H**

Werkstoff: Al

**Steering housing - H**

Material: aluminum

**转向器壳体 - H**

材料: 铝合金



**Lenkgehäuse - E**

Werkstoff: Al

**Steering housing - E**

Material: aluminum

**转向器壳体 - E**

材料: 铝合金

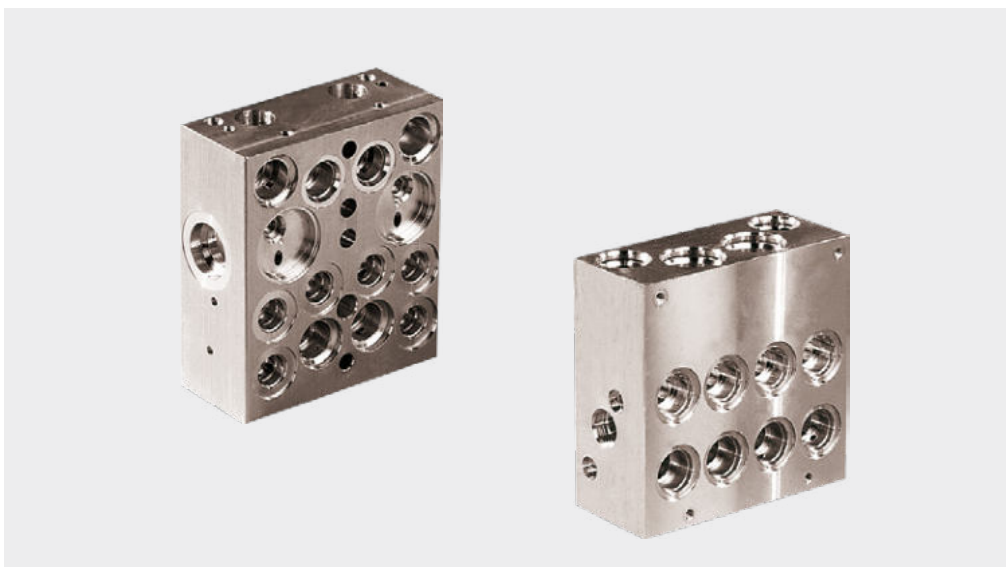

**ABS-Ventilgehäuse**

Werkstoff: Al

**ABS valve body**

Material: aluminum

**ABS 阀体**

材料: 铝合金

**Pumpengehäuse**

Werkstoff: Al

**Pump housing**

Material: aluminum

**动力转向泵壳**

材料: 铝合金

**Lenkgabel / Lenzapfen**

Werkstoff: St

**Universal joint**

Material: steel

**万向节**

材料: 钢

**Ventilgehäuse**

Werkstoff: GG

**Valve body**

Material: gray cast iron

**伺服转向阀体**

材料: 灰铸铁

**Deckel**

Werkstoff: Al

**Cover**

Material: aluminum

**盖**

材料: 铝合金

## Automotive – Automotive – 汽车行业

Innenraum – Interior – 内饰件

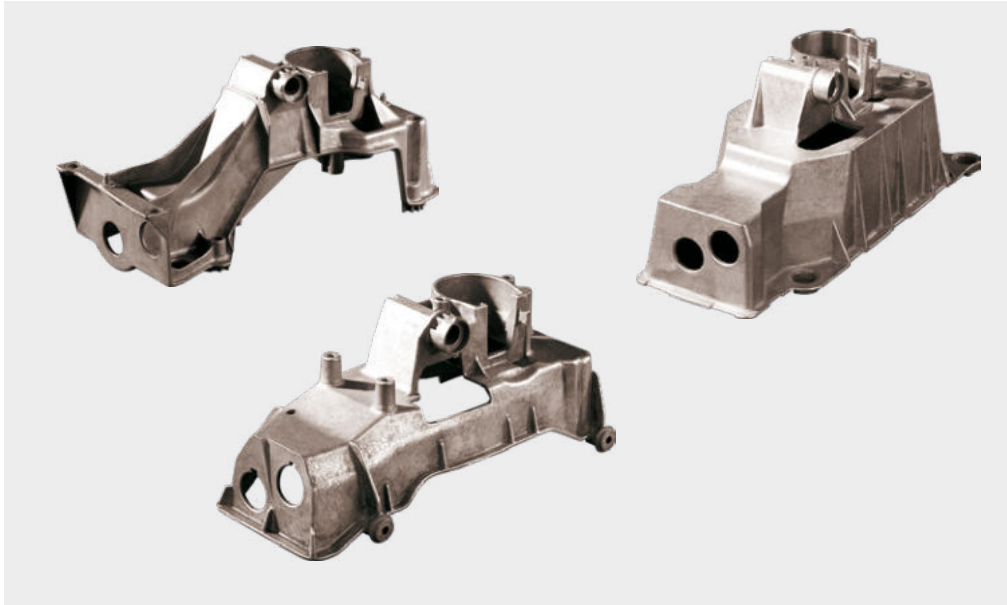

### Schalthebelgehäuse

Werkstoff: Mg

### Gear lever case

Material: magnesium

### 齿轮手柄壳

材料: 镁合金



### Ausgleichsgewicht

Werkstoff: GG

### Counter balance weight

Material: gray cast iron

### 配重件

材料: 灰铸铁



### Fußhebellagerwerk

Werkstoff: Al

### Pedal console

Material: aluminum

### 踏板控制台

材料: 铝合金

# Automotive – Automotive – 汽车行业

## Motor – Engine – 发动机

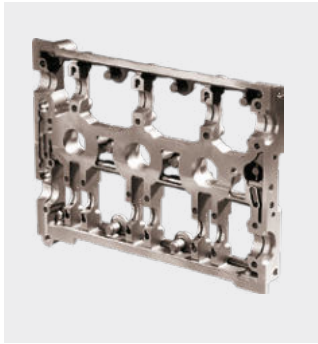

**Leiterrahmen für  
Nockenwellenlagergehäuse**

Werkstoff: Al

**Engine bulkhead housing**

Material: aluminum

**发动机隔离罩**

材料: 铝合金



**Gehäuse für  
Flügelzellenpumpe**

Werkstoff: Al

**Body for vane-type pump**

Material: aluminum

**叶轮泵壳体**

材料: 铝合金

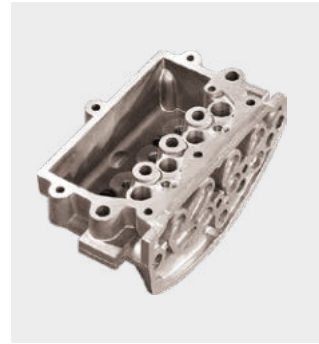

**Gehäuse**

Werkstoff: Al

**Housing**

Material: aluminum

**壳体**

材料: 铝合金



**Zahnradpumpegehäuse**

Werkstoff: Al

**Gear pump housing**

Material: aluminum

**齿轮泵壳体**

材料: 铝合金



**Ölpumpegehäuse**

Werkstoff: Al

**Oil pump housing**

Material: aluminum

**机油泵壳**

材料: 铝合金



**Ölpumpendeckel**

Werkstoff: Al

**Oil pump cover**

Material: aluminum

**机油泵盖**

材料: 铝合金



**Kipphebel**

Werkstoff: St

**Rocker arm**

Material: steel

**摇臂**

材料: 钢

# Automotive – Automotive – 汽车行业

## Motor – Engine – 发动机

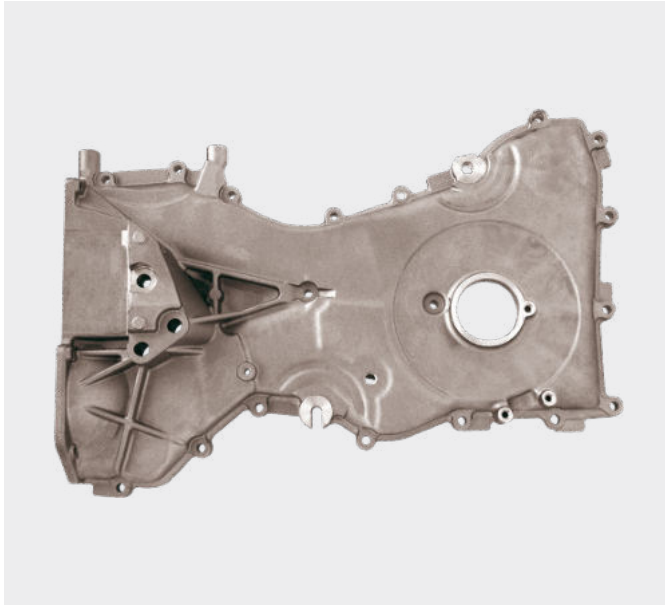

### Stirndeckel

Werkstoff: Al

### Front cover

Material: aluminum

### 前盖

材料: 铝合金



### Ventilgehäuse

Werkstoff: GGG

### Valve housing

Material: gray cast iron

### 阀体

材料: 灰铸铁



### Kurbelwellenlagerdeckel

Werkstoff: GGG

### Crank shaft bearing cap

Material: gray cast iron

### 曲轴轴承盖

材料: 灰铸铁



### Wasserpumpe

Werkstoff: GG

### Water pump

Material: gray cast iron

### 水泵

材料: 灰铸铁



### Dichtflansch

Werkstoff: Al

### Gasket flange

Material: aluminum

### 垫片法兰

材料: 铝合金



### Dichtflansch, hinten

Werkstoff: Al

### Seal flange, rear

Material: aluminum

### 后端密封法兰

材料: 铝合金

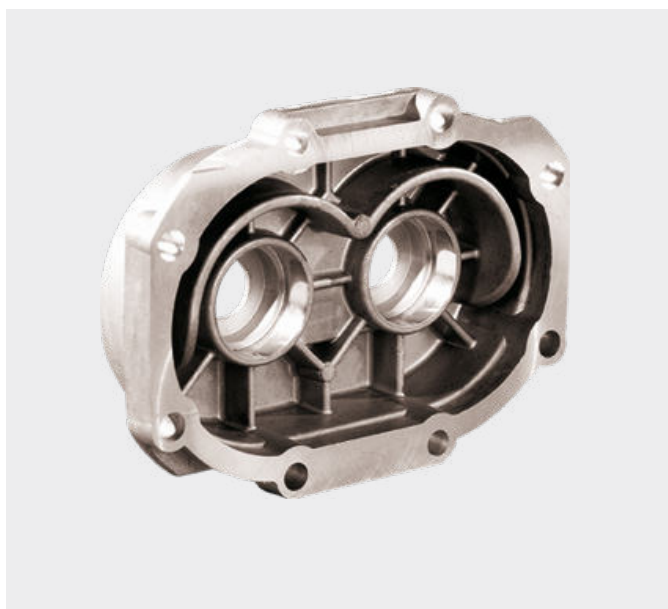

### Kompressorlagerdeckel

Werkstoff: Al

### Bearing cover

Material: aluminum

### 轴承罩

材料: 铝合金



### Kompressorgehäuse

Werkstoff: Al

### Turbocharger Housing

Material: aluminum

### 涡轮增压器壳

材料: 铝合金



### Ölfilterhalter

Werkstoff: Al

### Oil filter support

Material: aluminum

### 油滤器支架

材料: 铝合金

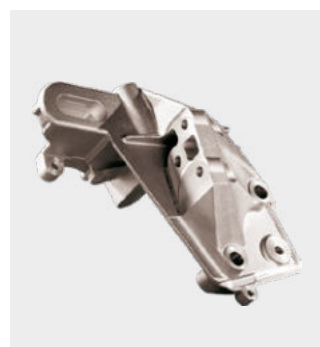

### Motorhalter

Werkstoff: Al

### Combi bracket

Material: aluminum

### 复合支架

材料: 铝合金



### Nockenwellenlagerdeckel

Werkstoff: Al

### Camshaft bearing cover

Material: aluminum

### 凸轮轴轴承盖

材料: 铝合金



### Antriebslager

Werkstoff: Al

### Bearing end shield

Material: aluminum

### 轴承护罩

材料: 铝合金

## Automotive – Automotive – 汽车行业

Motor – Engine – 发动机

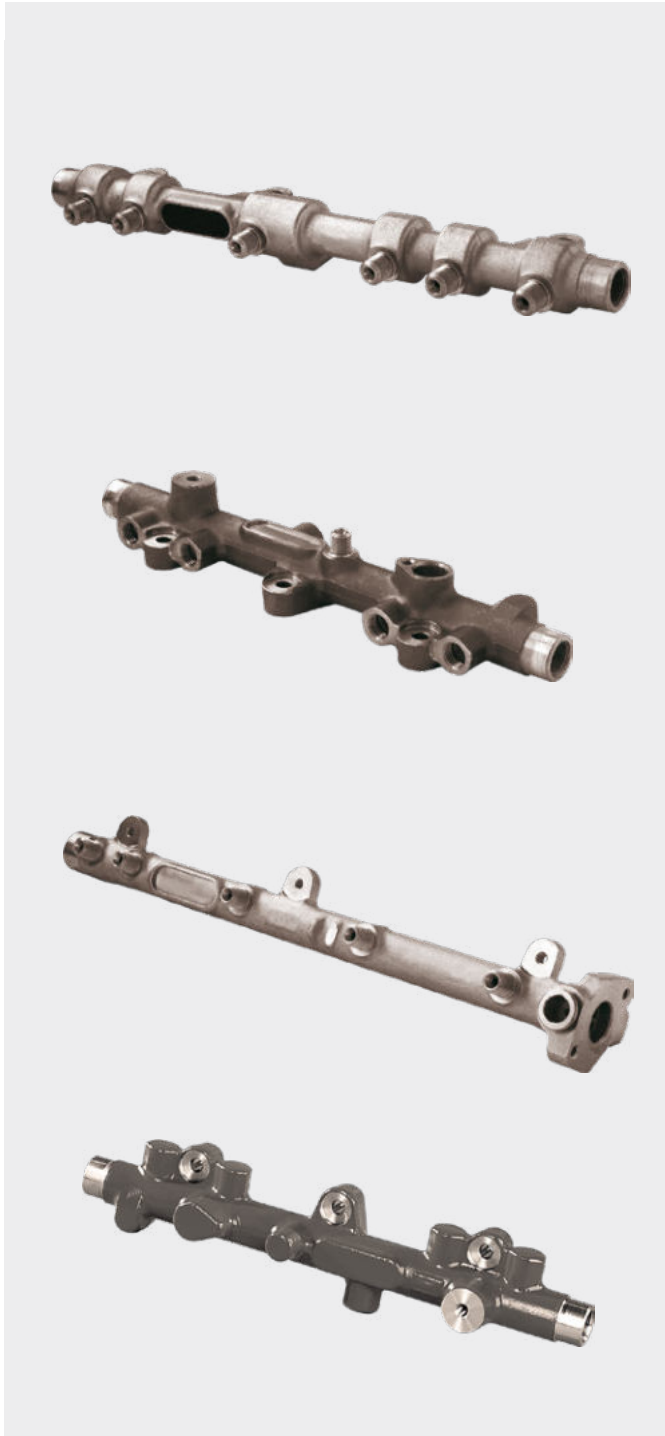

### Common Rail

Werkstoff: St

### Common rail

Material: steel

### 共轨管

材料: 钢

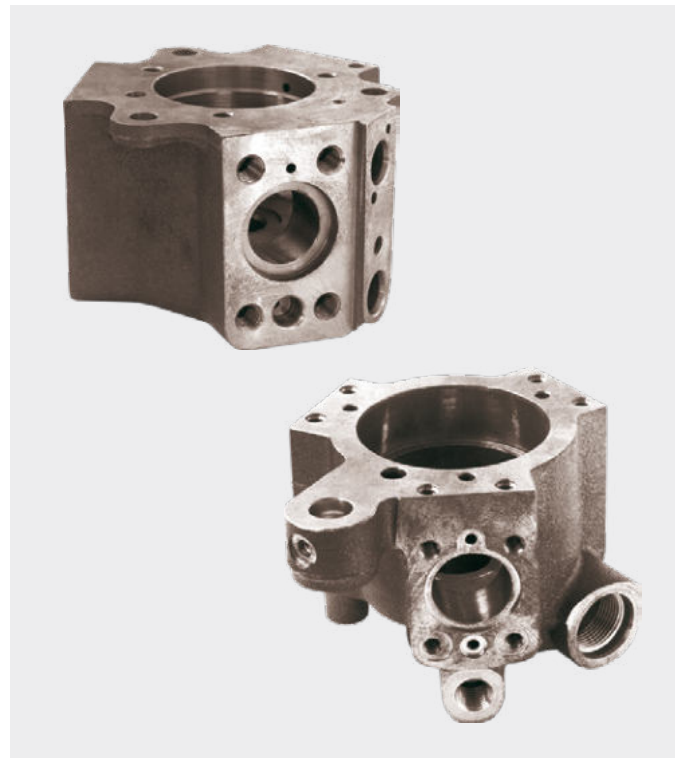

### Pumpengehäuse Common Rail

Werkstoff: GGG

### Pump casing for diesel injection

Material: gray cast iron

### 柴油喷射泵壳

材料: 灰铸铁



# Automotive – Automotive – 汽车行业

Motorrad – Motorcycle – 摩托车

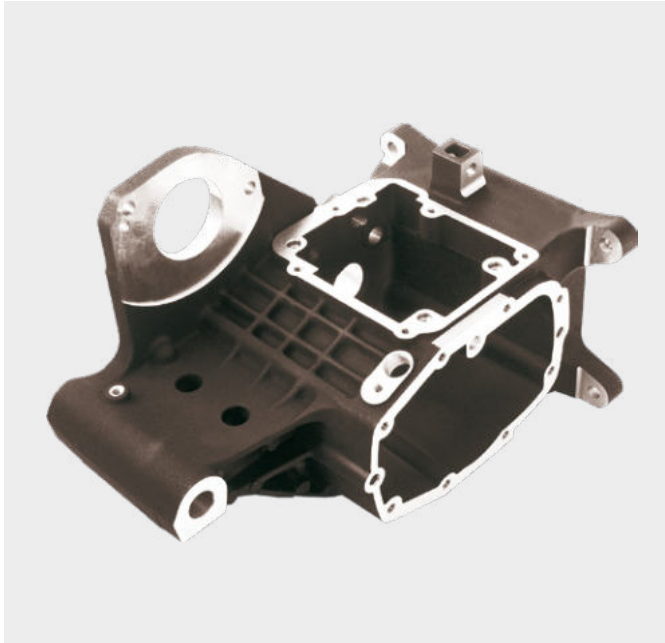

## Getriebegehäuse

Werkstoff: Al

## Transmission case

Material: aluminum

## 变速箱壳体

材料: 铝合金



## Zylinderkopf

Werkstoff: Al

## Cylinder head

Material: aluminum

## 缸盖

材料: 铝合金



## Kurbelgehäuse

Werkstoff: Al

## Crank case

Material: aluminum

## 曲轴箱体

材料: 铝合金

## Automotive – Automotive – 汽车行业

E-Antrieb – E-drives – 电动汽车

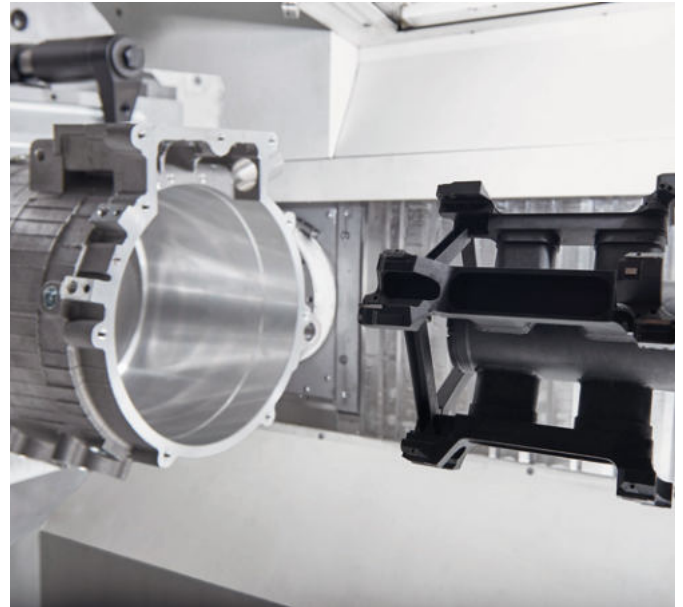

### E-Motor Gehäuse

Werkstoff: Aluminium / Guß

### E drive housing

Material: aluminium / cast iron

### 新能源电机壳

材料: 铝/铸铁

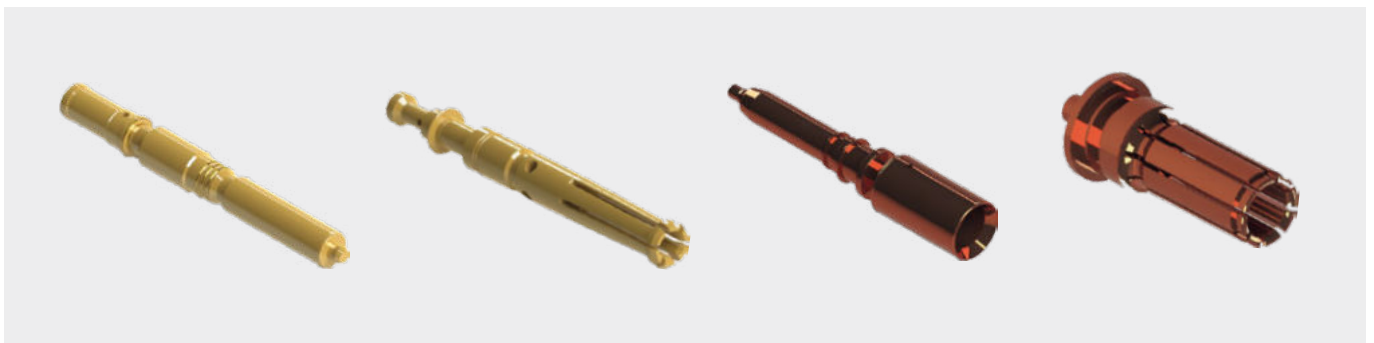

### Stecker

Werkstoff: Kupfer, Messing (bleifrei)

### Plugs

Material: cooper, brass (lead free)

### 接头

材料: 紫铜/黄铜 (无铅)

# Armaturen / Sanitär – Faucet / Fittings – 水暖行业

Gebäudeinstallation – Plumbing – 管道设备



## Doppelpumpengehäuse

Werkstoff: GG

## Double pump housing

Material: gray cast iron

## 双泵壳体

材料: 灰铸铁

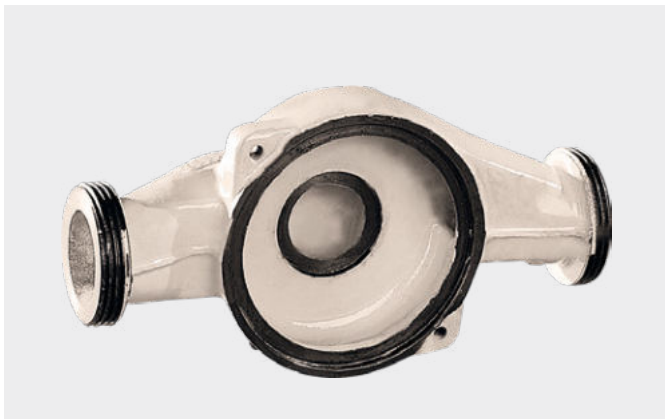

## Pumpengehäuse

Werkstoff: GG

## Pump housing

Material: gray cast iron

## 泵壳

材料: 灰铸铁



## Ventilgehäuse

Werkstoff: GJMB

## Valve housing

Material: malleable iron

## 阀体

材料: 锻钢



## Pumpengehäuse

Werkstoff: GG

## Pump housing

Material: gray cast iron

## 泵壳

材料: 灰铸铁



## Armaturengehäuse

Werkstoff: GG

## Armature housing

Material: gray cast iron

## 转子外壳

材料: 灰铸铁

# Armaturen / Sanitär – Faucet / Fittings – 水暖行业

## Fittings – Fittings – 管件

### Zerspanen und Umformen in der gleichen Maschine – in einer Aufspannung

Cutting and forming in one machine – in one set-up

在一台机床中加工和成型 – 一次装夹



#### Press-Fittings (Muffen)

Werkstoff: Edelstahl

#### Fittings (coupling)

Material: stainless steel

#### 管件(管箍)

材料: 不锈钢



#### Press-Fittings (Bögen)

Werkstoff: Edelstahl

#### Fittings (elbow)

Material: stainless steel

#### 管件

材料: 不锈钢



#### Press-Fittings (T-Stücke)

Werkstoff: Edelstahl

#### Fittings (tee)

Material: stainless steel

#### 管件(三通)

材料: 不锈钢



#### Press-Fittings (T-Stücke)

Werkstoff: Cu

#### Fittings (tee)

Material: copper

#### 管件(三通)

材料: 铜



#### Löt-Fittings

Werkstoff: Cu

#### Fittings

Material: copper

#### 管件

材料: 铜



#### Press-Fittings (Bögen)

Werkstoff: Cu

#### Fittings (elbow)

Material: copper

#### 管件(弯管)

材料: 铜



**Verteiler Wandabschluss**

Werkstoff: Ms

**Distribution device**

Material: brass

**管件**

材料: 黄铜



**Gasventil**

Werkstoff: Ms

**Gas valve**

Material: brass

**燃气阀**

材料: 黄铜



**Fittings**

Werkstoff: Ms

**Fittings**

Material: brass

**管件(弯管)**

材料: 黄铜

# Armaturen / Sanitär – Faucet / Fittings – 水暖行业

## Mischarmaturen – Faucets – 水龙头



### Einhandmischer

Werkstoff: Ms

### Single lever faucet

Material: brass

### 单柄龙头

材料: 黄铜



### Zweigriffarmatur

Werkstoff: Ms

### Two handle faucet

Material: brass

### 双柄龙头

材料: 黄铜

### Mischarmatur

Werkstoff: Ms

### Two handle faucet

Material: brass

### 双柄龙头

材料: 黄铜



### Thermostatgehäuse

Werkstoff: Ms

### Thermostat housing

Material: brass

### 节温器壳体

材料: 黄铜

# Armaturen / Sanitär – Faucet / Fittings – 水暖行业

## Verschraubungen – Screw fittings – 螺纹连接件



### T-Stück

Werkstoff: Ms

### Tee

Material: brass

### 三通

材料: 黄铜



### Winkel-Anschlussstück

Werkstoff: Ms

### 90° adapter fitting

Material: brass

### 90° 转接弯头

材料: 黄铜



### Verschraubung

Werkstoff: St

### Tee

Material: steel

### 三通

材料: 钢

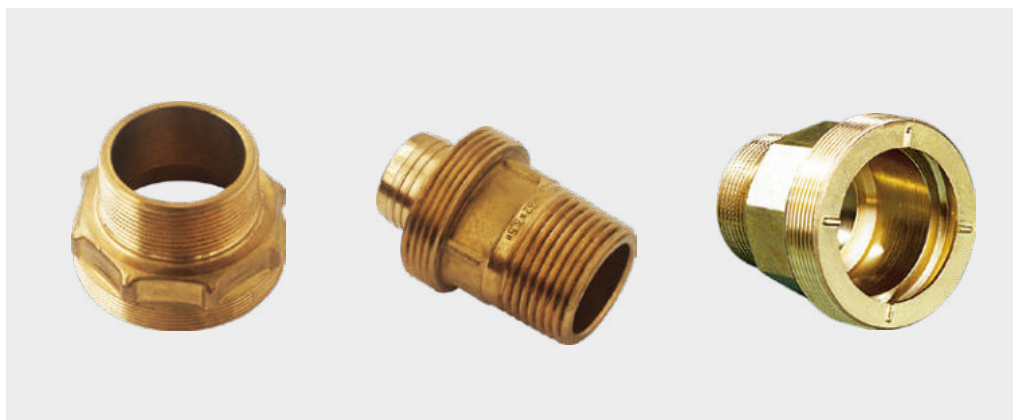

### Verschraubung

Werkstoff: Ms (bleifrei)

### Reducer

Material: brass (lead free)

### 异径管接头

材料: 黄铜 (无铅)



### Armaturengehäuse

Werkstoff: Ms

### Armature housing

Material: brass

### 转子壳体

材料: 黄铜



### Gasflaschenventil

Werkstoff: Ms

### Gas bottle valve

Material: brass

### 燃气管阀

材料: 黄铜



### Schrägsitzventil

Werkstoff: Ms

### Angular valve

Material: brass

### 角向阀

材料: 黄铜



### Verschraubung

Werkstoff: St

### 90° elbow

Material: steel

### 90°弯头

材料: 钢

# Armaturen / Sanitär – Faucet / Fittings – 水暖行业

Verteilergehäuse – Manifold housings – 歧管



**Zylinderkopf für Hochdruckreiniger**

Werkstoff: Ms

**Cylinder head for high-pressure cleaner**

Material: brass

**高压清洁器缸头**

材料: 黄铜



**Verteiler Wandabschluss**

Werkstoff: Ms

**Distributor**

Material: brass

**分配器**

材料: 黄铜



**Verteiler**

Werkstoff: Ms

**Water mixing valve**

Material: brass

**混水阀**

材料: 黄铜



**Armaturenformstück**

Werkstoff: Ms

**Valve**

Material: brass

**阀**

材料: 黄铜



## Industrial Equipment – Other industry branches – 工业设备

Baumaschinen / Mobilhydraulik – Construction equipment / Mobile Hydraulic – 建筑设备 / 移动液压



### Kettenglieder

Werkstoff: St

### Chain links

Material: steel

### 链节

材料: 钢



### Hydraulikpumpengehäuse

Werkstoff: GG

### Hydraulic pump housing

Material: gray cast iron

### 液压泵壳体

材料: 灰铸铁



### Ventilgehäuse

Werkstoff: Edelstahl

### Valve housing

Material: stainless steel

### 阀壳体

材料: 不锈钢



### Filterkopf für Baumaschinen

Werkstoff: GG

### Filter head for construction machines

Material: gray cast iron

### 建筑设备过滤器头

材料: 灰铸铁

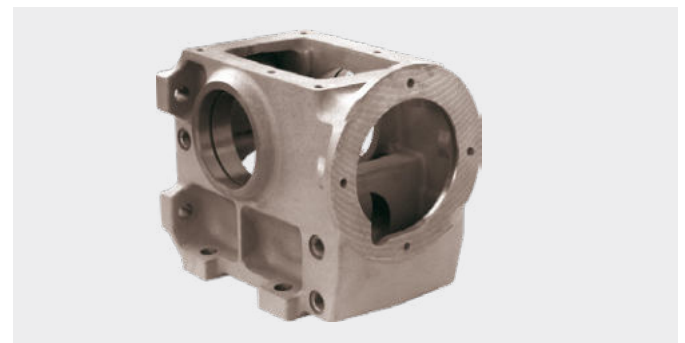

### Getriebegehäuse

Werkstoff: GG

### Gear box housing

Material: gray cast iron

### 齿轮箱

材料: 灰铸铁

## Industrial Equipment – Other industry branches – 工业设备

Waschmaschine – Washing machines – 洗衣机

Kompressoren – Compressors – 压缩机

Türschließgehäuse – Door lock housings – 闭门器

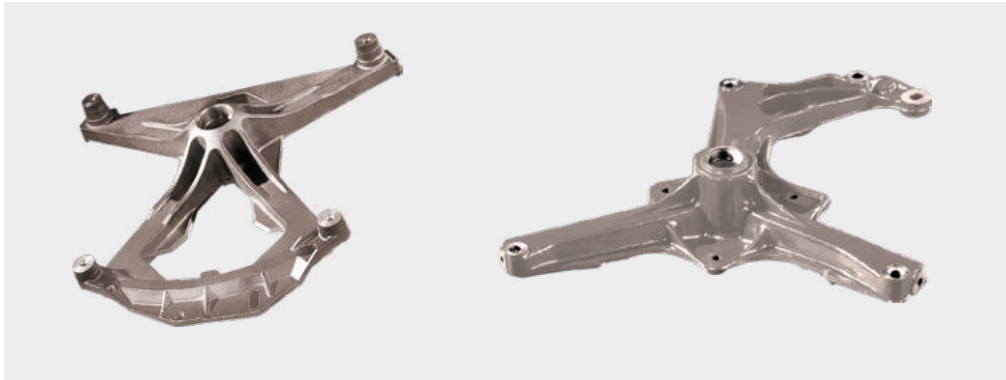

### Waschmaschinen-Lagerkreuz

Werkstoff: GG

#### Cast bracket for washing machine drum

Material: gray cast iron

#### 洗衣机滚筒支架

材料: 灰铸铁



### Ausgleichsgewicht

Werkstoff: GG

#### Balancing weight

Material: gray cast iron

#### 配重

材料: 灰铸铁



### Kompressorgehäuse für Transportkühlanlagen

Werkstoff: Al

#### Compressor housing

Material: aluminum

#### 压缩机壳体

材料: 铝合金



### Kühlschrank-Kompressorgehäuse

Werkstoff: GG

#### Compressor housing refrigerator

Material: gray cast iron

#### 冰箱压缩机缸体

材料: 灰铸铁



### Türschließgehäuse

Werkstoff: GG

#### Door lock housings

Material: gray cast iron

#### 闭门器壳体

材料: 灰铸铁



### Türschließgehäuse

Werkstoff: Al

#### Door lock housing

Material: aluminum

#### 闭门器壳体

材料: 铝合金

## Industrial Equipment – Other industry branches – 工业设备

Zapfhahngehäuse – Fuel filler nozzle housing – 加油器喷嘴壳体

Werkzeug – Tools – 工具

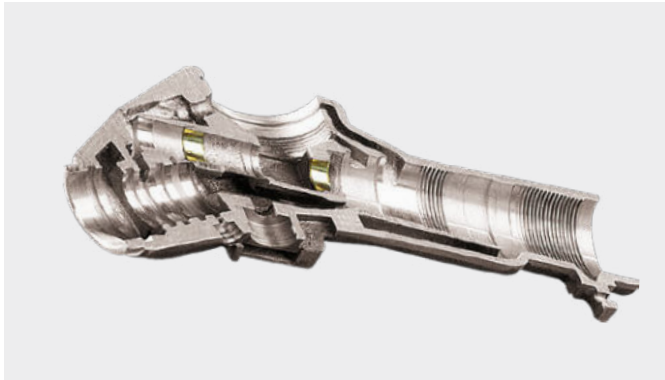

### Treibstoff-Zapfhahngehäuse

Werkstoff: Al

### Fuel filler nozzle housing

Material: aluminum

### 燃气过滤嘴壳体

材料: 铝合金



### Kombizange

Werkstoff: St

### Universal pliers

Material: steel

### 通用钳子

材料: 钢



### Lagerschild für Bohrmaschine

Werkstoff: Al

### Bearing support for hammer drill

Material: aluminum

### 冲击钻轴承座

材料: 铝合金



### Getriebegehäuse für Bohrmaschine

Werkstoff: Al

### Gear housing for hammer drill

Material: aluminum

### 冲击钻齿轮壳

材料: 铝合金

# Fräsen – Mehrwegetechnologie

## Multi-way milling technology

### 多路径铣削技术

Witzig & Frank bietet eine große Bandbreite an Lösungen für die Volumenfertigung – vom klassischen, hochproduktiven Transfersystem bis zu flexiblen Mehrstationen- und Mehrspindelbearbeitungszentren. Das Anwendungsspektrum reicht vom Automobil-Antriebsstrang über Sanitär-Armaturen, Komponenten für Baumaschinen, Elektromotoren, aber auch Waschmaschinen oder Handwerkzeuge. Das Technologie-, Turnkey- und Anlagen-Knowhow von Witzig & Frank umfasst eine große Auswahl an Bearbeitungstechnologien, Spannmitteln, Automationslösungen, Antriebs- und Steuerungsvarianten.

Witzig & Frank offers a broad range of equipment and technologies for volume production – from proven, highly productive transfer systems to flexible multi-station, multi-spindle machining centers. Applications include automotive powertrain components, faucet, fittings, construction equipment, electrical engines, as well as household equipment and hand tools.

Witzig & Frank's technology, turnkey and systems knowhow comprises various machining technologies, clamping and fixturing variants, automation and workpiece handling as well as control and drive options.

Witzig & Frank 为大批量生产提供多种设备和技术—从经过验证, 高效的自动线系统到柔性多工位、多主轴加工中心。应用包括汽车动力总成零部件、球笼、管接头件、建筑设备、电动发动机, 以及家用设备和手动工具。Witzig & Frank的技术, 交钥匙和系统专有技术包括各种加工技术, 装夹和夹具变型, 自动化和工件装卸以及控制和驱动器选项。

### Maschinenkonzepte

- ▶ TURMAT – Mehrwege-Rundtransfermaschine
- ▶ LSA – Mehrwege-Fertigungszelle mit horizontaler Schaltachse
- ▶ TRIFLEX – Modulares Mehrstationen-Bearbeitungszentrum
- ▶ TWINFLEX – mehrspindliges Zweistationen-CNC-Bearbeitungszentrum

### Machine models

- ▶ TURMAT – Multi-way rotary transfer machine – vertical
- ▶ LSA – Multi-way manufacturing cell – horizontal
- ▶ TRIFLEX – Modular multi-station machining center
- ▶ TWINFLEX – two-station multi-spindle machining center

### 模块化机床

- ▶ TURMAT – 多工位回转自动线
- ▶ LSA – 多路径制造单元
- ▶ TRIFLEX – 模块化,多工位加工中心,一次装夹5面加工
- ▶ TWINFLEX – 多主轴双工位加工中心

### Technologieanwendungen –

### Technology examples – 应用案例

Witzig & Frank Maschinen sind mit einer großen Auswahl an Bearbeitungseinheiten optimal für die Komplettbearbeitung ausgelegt.

Witzig & Frank machines are ideally suited for integrated machining solutions.

Witzig & Frank机床是理想的集成加工解决方案



Witzig & Frank online Video  
维茨希·弗兰克在线视频

### Fräsen

Milling

铣削



### Bohren

Drilling

钻削



### Räumen

Broaching

拉削



### Innen Ausdrehen

Inside turning

内圆车削

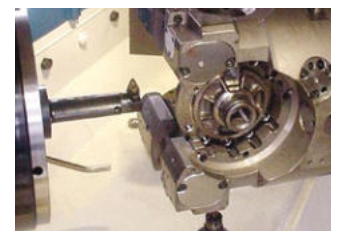

# Anwendungsbereiche

Application range

工业应用

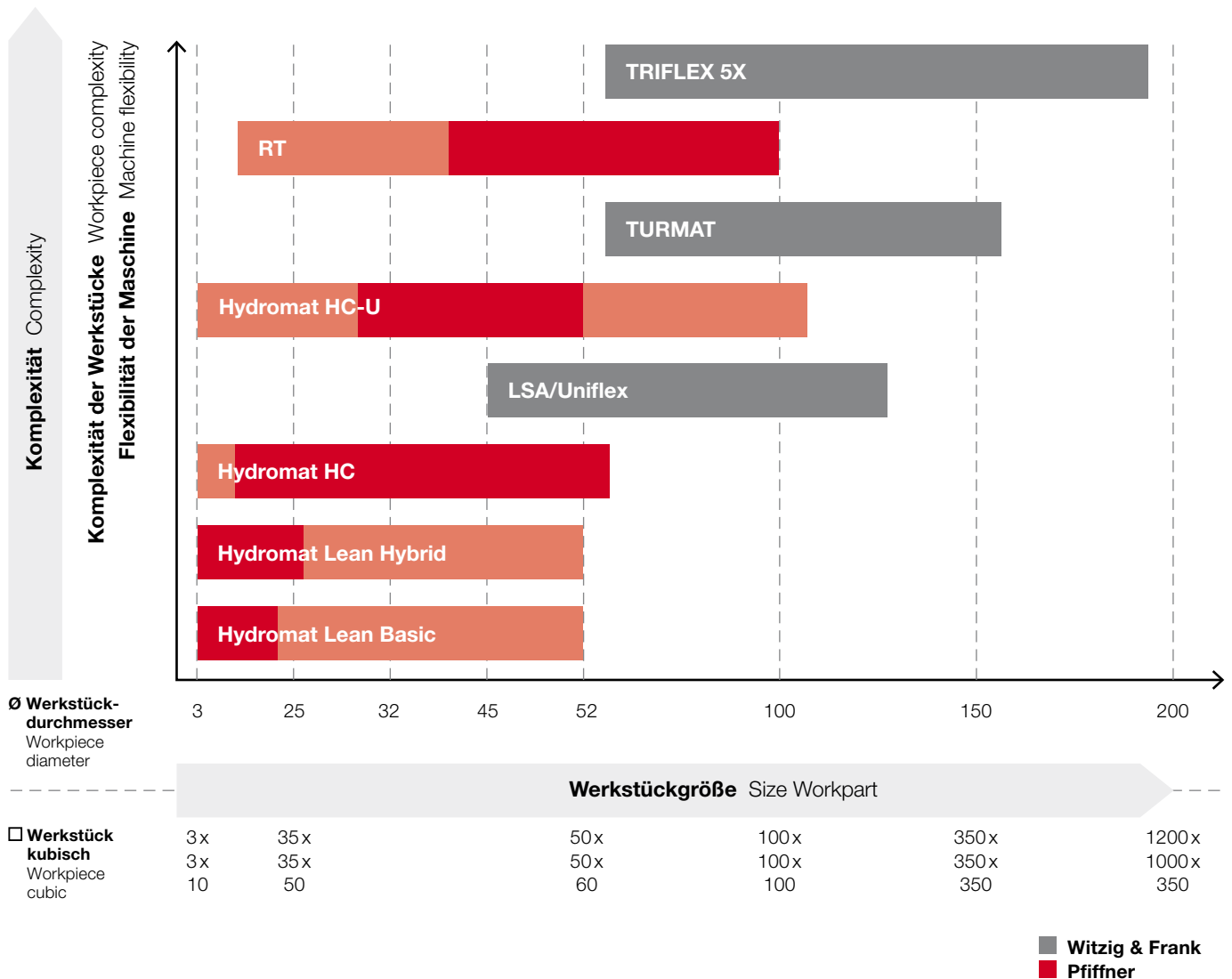

## Zirkular Gewinden

Threading

螺纹



## Aussteuerwerkzeuge

Draw bar tools

拉杆刀具

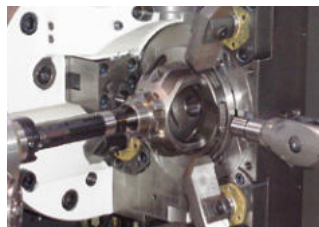

## Büchsen Einpressen

In-process bush pressing

同期衬套压装



## Hontechnik

Honing technology

珩磨技术



# Service and Support

## WITZIG & FRANK Services

We offer professional services for your highly productive machines and plants. Whether it's a matter of keeping the availability of your plants as high as possible or adapting them in line with necessary changes in order to continue producing products at a high level. As your partner, we want to use our know-how to help us to be successful together.

- ▶ **Hotline / Remote service**
- ▶ **Inspection**
- ▶ **Repairs**
- ▶ **Process optimization (OEE)**
- ▶ **Spare parts**  
Top quality and maximum lifetime with original Witzig & Frank spare parts
- ▶ **Retooling**

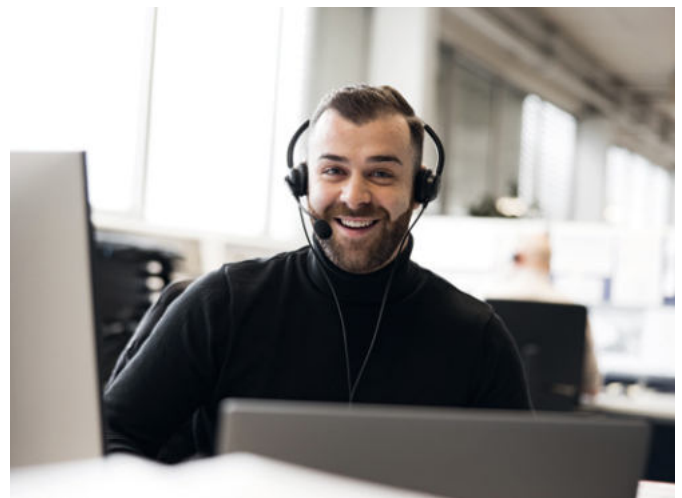

## Service Products

Investment where it really pays off

- ▶ **Exchange assemblies**
- ▶ **Retrofit kit/remote access**
- ▶ **Replacement assemblies for quick on-site exchange**
- ▶ **Service agreements**
- ▶ **Training**
- ▶ **Revest®**  
The rejuvenation treatment for your Witzig & Frank transfer machines

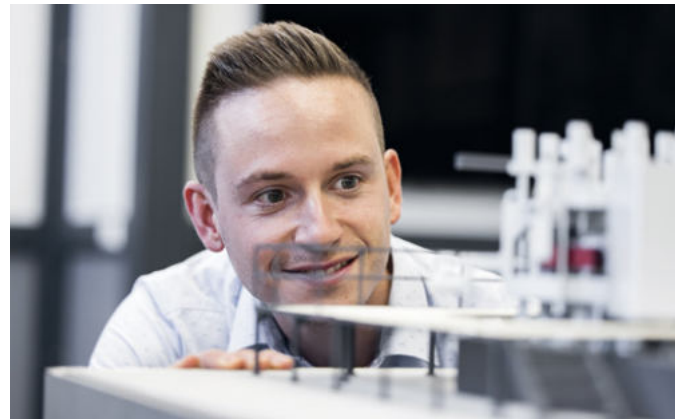

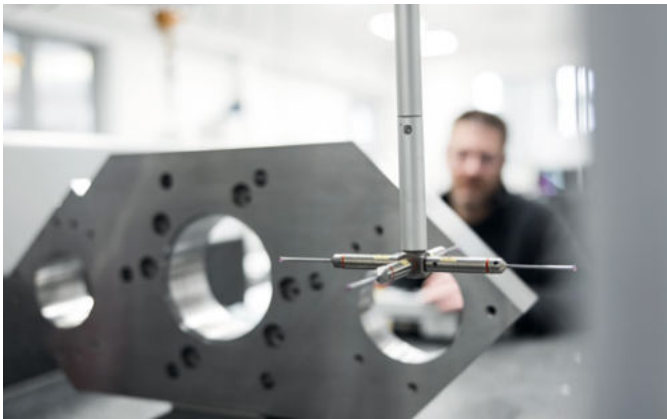

### **Germany**

Witzig & Frank / K.R. Piffner GmbH  
Am Holderstock 2  
DE-77652 Offenburg  
Tel.: +49 781 289 0  
Fax: +49 781 289 1303  
[www.witzig-frank.com](http://www.witzig-frank.com)

### **Service/Parts Hotline/Website**

Tel.: +49 781 289 1000  
[service@witzig-frank.com](mailto:service@witzig-frank.com)



### **USA**

MAG Automotive LLC  
6015 Center drive  
US-MI 48312 Sterling Hights  
Tel.: +1 586 446 7000  
Fax: +1 586 335 4490

### **Service/Parts Hotline/Website**

Tel.: +1 888 858 9920  
[MAG-Automotive.Serviceparts@mag-ias.com](mailto:MAG-Automotive.Serviceparts@mag-ias.com)



## Über FFG Europe & Americas

FFG Europe & Americas vereint große Traditionen der deutschen, italienischen, schweizerischen und amerikanischen Werkzeugmaschinenindustrie in einer Gruppe und bietet mit den Marken VDF Boehringer, Hessapp, Jobs, MAG, Meccanodora, Modul, Morara, Pfiffner, Rambdaudi, Sachman, Sigma, SMS, Tacchella und Witzig & Frank ein herausragendes Portfolio an Dreh-, Fräs-, Schleif- und Verzahnmaschinen und eine einzigartige Know-how-Basis. Seit 1798 tragen diese Marken zum Fortschritt in der Produktionstechnik bei und gelten heute als zuverlässige und innovative Ausrüster für die Automobil- und Nutzfahrzeugindustrie, die Luft- und Raumfahrt, den Maschinenbau, die Metallverarbeitung, die Schienenverkehrstechnik, die Energietechnik und die Schwerindustrie. Als eigenständige Einheit profitieren die Premiumhersteller im Verbund der FFG-Unternehmen von der Größe und den Möglichkeiten der globalen Gruppe.

## About FFG Europe & Americas

The FFG entities in Europe and the Americas unite major players from the German, Italian, Swiss and American machine tool industry with a broad range of milling, turning, grinding, and gear manufacturing technology, and the knowhow of the renowned machine tool brands VDF Boehringer, Hessapp, Jobs, MAG, Meccanodora, Modul, Morara, Pfiffner, Rambdaudi, Sachman, Sigma, SMS, Tacchella and Witzig & Frank. Since 1798, these brands have substantially contributed to the progress in industrial manufacturing and are well known as reliable and innovative equipment and systems solutions suppliers for the automotive and truck, aerospace, machine building, general machining, railway industry, energy and heavy engineering industries. While being an independent group, these entities benefit from the strengths and opportunities of the global Fair Friend Group. They stand for premium technology within FFG.

## 关于FFG欧美集团

FFG欧美集团作为技术领先的机床集团，拥有众多知名品牌：VDF Boehringer（柏林格爾）、Hessapp（海瑟普）、Jobs（乔布斯）、MAG、Meccanodora（麦克诺朵拉）、MODUL（模德）、Morara（莫罗拉）、Pfiffner（佩非勒）、Rambdaudi（蓝苞蒂）、Sachman（萨克曼）、SIGMA（西格玛）、SMS、Tacchella（塔凯拉）及Witzig & Frank（维茨希·弗兰克）等。作为杰出的技术集成商和设备制造商，我们以完美的工艺技术及在此基础上量身定做的生产解决方案而闻名。拥有丰富的产品线及技术，包括铣削、车削、磨削、齿轮加工技术、系统集成、复合材料加工、维修、工控系统及软件、核心零部件等。自1798年以来，FFG欧美集团旗下各大品牌不断推动着世界工业制造业的发展与进步，广泛服务于航空航天、汽车、重型机械、能源、轨道交通、机床制造及通用加工等行业。作为独立的实体公司，同时又隶属于全球友嘉（FFG）实业集团，FFG欧美集团各品牌受益于友嘉集团的强大实力及资源，并代表友嘉集团最先进的技术。

### K.R. Pfiffner AG

Sonnmattstrasse 28  
CH-3427 Utzenstorf  
Tel.: +41 32 666 35 35  
Fax: +41 32 666 35 55  
www.pfiffner.com

### Witzig & Frank / K.R. Pfiffner GmbH

Am Holderstock 2  
DE-77652 Offenburg  
Tel.: +49 781 289 0  
Fax: +49 781 289 1303  
www.witzig-frank.com

FFG Europe & Americas

info@ffg-ea.com

www.ffg-ea.com